

OverDRIVE

Warranty
10
YEAR

Compliant
IEC
62471

Compliant
CE
RoHS

Rated
IP
50

Max Strobe
5000
per second

PRODUCT HIGHLIGHTS

- ✓ Capable of producing up to 5000 strobes per second
- ✓ Pulse energy of up to 2000 W when LEDs are active
- ✓ Built-in driver
- ✓ PNP and NPN trigger signal input
- ✓ SafeStrobe™ technology ensures protected operation of LEDs





PRODUCT DESCRIPTION

The XR256 Series High-Speed Strobe Light is a high speed, high power, pulse-initiated or pulse following strobe with a maximum output of 5000 strobes per second and a pulsed energy rating of 2000 W. The XR256 offers eight manually controlled settings between a 20 μ s to 1000 μ s strobe pulse duration in pulse-initiated mode and features a preprogrammed 2% duty cycle. The XR256 Series also features SafeStrobe™ technology protects LEDs from overheating and premature degradation.



PRODUCT SPECIFICATIONS

Electrical Input	24VDC +/- 5%
Input Current	Max current 20 A for max. 15 ms
Wattage	Up to 2000 W
Duty Cycle	Max 2%
Strobe/Pulse	Light will trigger on leading edge of pulse
Strobe Rate	Max. 5000 strobes per second (see SafeStrobe™ Technology for more information)
Yellow Indicator LED	Over temperature — Cool down mode active
Green Indicator LED	Power on
Red Indicator LED	LED strobe indicator
Pulse-Initiated Strobe	8 Settings: 20 μ S — 1000 μ s
Time Delay ON	1 μ S — Full ON
Pulse Following Strobe	Light will track strobe pulse – Max. strobe of 40 ms
Connection	5-position screw terminal block (5-position terminal block plug included)
Ambient Temperature	0°-40° C (32°-104° F)
IP Rating	IP50
Weight	~1820g
Compliances	CE, RoHS, IEC 62471
Warranty	10 year warranty. For complete warranty information, visit smartvisionlights.com/warranty .



WIRING CONFIGURATION

The XR256 comes with a 5-position terminal block plug.

Wired for Pulse Initiated

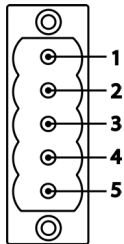

Pin layout for light (Male Connector)

Pins	Function	Signal
1	Power In	+24 V DC
2	NPN	NOT USED
3	PI	Pulse Initiated
4	PNP	NOT USED
5	GND	Ground

Signal input must be a sourcing PNP input.
Strobe duration controlled by adjustment dial.

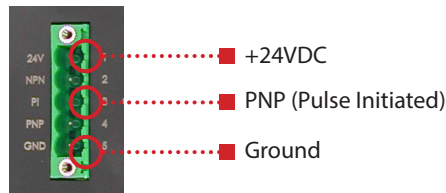

Wired for Pulse Following

Pins	Function	Signal
1	Power In	+24 V DC
2	NPN	Pulse Following
3	PI	NOT USED
4	PNP	Pulse Following
5	GND	Ground

Signal input can be sinking NPN or sourcing PNP.

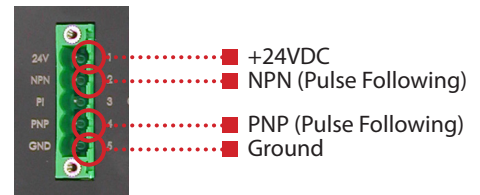

RESOURCE CORNER

Additional resources, including CAD files, videos, and application examples, are available on our website.



USING THE XR256

The XR256 high-speed strobe light is capable of producing up to 5000 strobes per second (SPS). The strobe can be either pulse-initiated or pulse following, adding versatility. Pin 2, NPN, is the sinking input in the pulse-following mode. Pin 4, PNP, is the sourcing input in the pulse-following mode. To pulse the LEDs, the XR Series of LED lights uses stored electrical energy. When LEDs are active, the XR256 has a pulse energy of 2000 watts. The XR256 light has a pulsed LED die current of 180 amps.

The XR256 light has 288 mm² (144 of 2 mm² high-power die) of LED die running at up to 2000 W. For comparison, a standard LED light for machine vision has on average 6–12 mm² of LED die running a 6–12 Watts.

The XR Series features an LED die temperature monitor that will temporarily shut down the light if the LEDs exceed the maximum running temperature of 80°C. The LED die will gain heat based on the LED duration and SPS. A high duty cycle or long durations with high SPS will cause the heat to rise in the die.



LIGHT PATTERNS

LIGHTING PATTERN FOR THE XR256 **with Standard 14° Lenses (14)**

Working Distance mm (inches)	Pattern (80%–100% measured intensity) mm (inches)
500 mm (~19.7")	155 mm (~7") D
1000 mm (~39.4")	360 mm (~14") D
Typical Output Performance	
Distance = 500 mm	Illumination (Lux) 700,000
<i>Illumination measurement taken on White Light, 5700 K</i>	

LIGHTING PATTERN FOR THE XR256 **with Wide 80° Lenses (W80)**

Working Distance mm (inches)	Pattern (80%–100% measured intensity) mm (inches)
500 mm (~19.7")	4400 mm (~173") D
1000 mm (~39.4")	8800 mm (~346") D
Typical Output Performance	
Distance = 500 mm	Illumination (Lux) 177,000
<i>Illumination measurement taken on White Light, 5700 K</i>	

Additional light output measurements available upon request.



LENSES

NARROW (14)

Narrow-angle lenses project a narrow beam of illumination. They can be used when longer distances are needed.



WIDE 30/50/80

Wide-angle lenses project a large area of illumination and can be used when short working distances are needed.

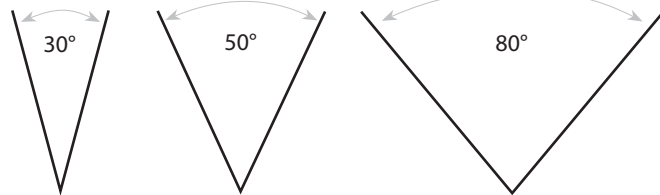

STROBE DURATION DIAL

The strobe duration dial only functions when the XR256 is in Pulse-Initiated mode. See Wiring Configuration for setting light to Pulse-Initiated mode.



Each number on the dial represents a strobe light pulse rate in microseconds (μs). When setting the dial to 250, for example, the light will pulse for 250 μs . The light will pulse for this length of time once it receives a PNP rising edge signal (the sourcing signal between 4 VDC and 24 VDC).

Setting the dial hand to "Auto" will automatically pulse the light for a set length of time. To set the length of time, turn the light on, point the dial hand to the desired length of time. Keep the dial hand on the desired time for three seconds and then position the dial hand on "Auto". The light will

be set to the length of time selected. When the light is set to Auto, no PNP signal (sourcing signal) is used. The light will pulse for the desired length of time and then enter into a rest period set using a 2% duty cycle. The light will repeat these two steps for as long as the light is on. For example, if light has been set to Auto at a rate of 20 μs , the light will pulse for 20 μs , rest for 98 μs , then repeat the active and rest periods.

Strobe Durations:

- 20 μs pulse
- 50 μs pulse
- 100 μs pulse
- 250 μs pulse
- 500 μs pulse
- 750 μs pulse
- 1000 μs pulse





SAFESTROBE™ TECHNOLOGY

SafeStrobe™ technology is a unique technology that applies safe working parameters to ensure high-current LED's are not damaged by driving them beyond their limits, such as maximum strobe time or duty cycle. This is especially beneficial for overdriving our high-current LED's.



INDICATOR LIGHTS

- Strobe  Strobe Active Indicator (Red)
- Over Temp  Over Temperature Indicator (Yellow)
- Power  Power Indicator (Green)

PRODUCT DRAWING

CAD files available on our website.
Dimensions are in mm.

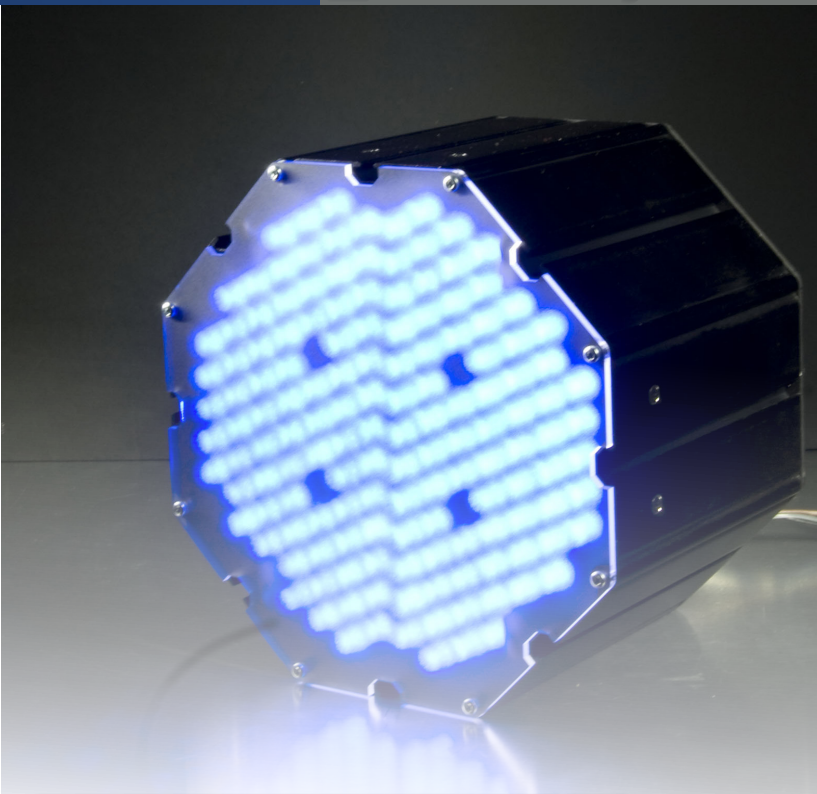
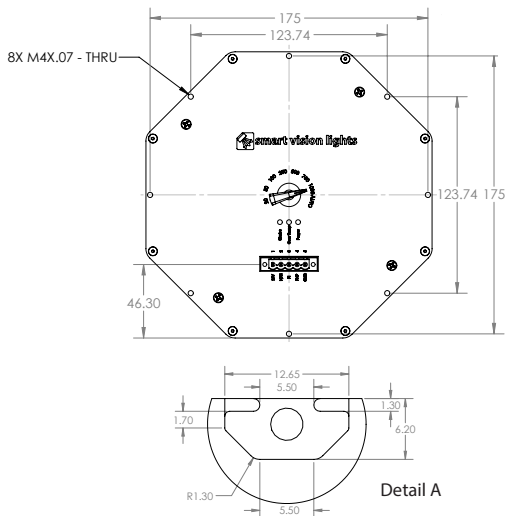
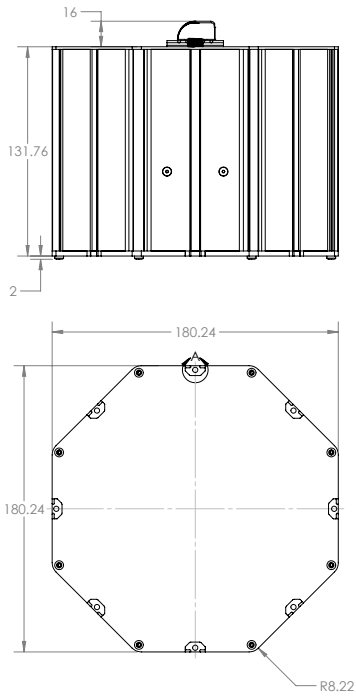

ILLUMINATION

XR256 Series of Strobe Lights works best for:

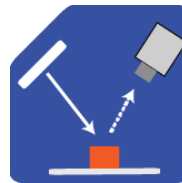

Bright Field

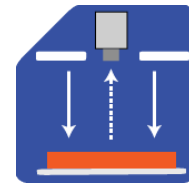

Direct

EYE SAFETY



According to IEC 62471:2006. Full documentation available upon request.

Notice

Exempt Group: No photobiological hazard to eyes or skin even for continuous, unrestricted use. Applicable for wavelengths: 625, 850, and 940.

Caution

Risk Group 1: Possibly hazardous optical radiation emitted from this product. Do not stare at operating lamp. May be harmful to eyes. Safe for most applications except prolonged exposure. Applicable for wavelengths: 470, 530, and WHI.



PART NUMBER

XR256



COLOR:



LENS:

- 14 = Narrow 14°
- W30 = Wide 30°
- W50 = Wide 50°
- W80 = Wide 80°

Part Number Examples:

- XR256-625** XR256, 625 Red Wavelength, Standard (Wide) Lenses
- XR258-WHI-W80** XR256, White, Wide 80° Lenses

Additional wavelengths and lens options available upon request.



MOUNTING

Mounting options include eight T-slots and eight M4 threaded holes.

Includes:

Two M5 x 10 mm screws and two M5 T-nuts included.

Mounting Options:

T-slots = M5 x 0.8 mm T-nut

Threaded screw holes = M4 screws

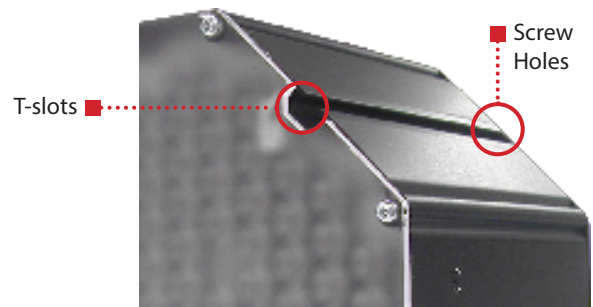

DUTY CYCLE (OVERDRIVE™ MODE ONLY)

This section applies only for OverDrive™ strobe mode.

The Duty Cycle (D) is related to the Strobe Time (ST) and Rest Time (RT).

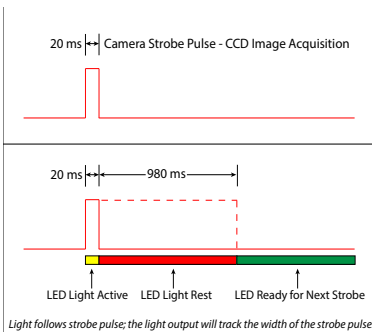

Calculating Rest Time

$$RT = \frac{ST}{D} - ST$$

RT = Rest Time
ST = Strobe Time
D = Duty Cycle

Example

$$980 \mu s = \frac{20 \mu s}{.02} - 20 \mu s$$

Rest Time is 49 μs for 10 μs Strobe Time

Calculating Strobe Rate

$$SR = \frac{D}{ST}$$

SR = Strobe Rate (strokes per second)
ST = Strobe Time (seconds)
D = Duty Cycle

Example

$$200 = \frac{0.02}{0.0001}$$

Strobe Rate is 200 strokes per second

Calculating Duty Cycle

$$D = ST \times SR$$

SR = Strobe Rate (strokes per second)
ST = Strobe Time (seconds)
D = Duty Cycle

Example

$$0.02 = 0.0001 \times 200$$

Duty Cycle is 2% (0.02)

Maximum Duty Cycle for OverDrive™ light is 2% (0.02)

Note: Strobe time is limited by the strobe rate.



GLOSSARY

This glossary covers all Smart Vision Lights product families; some content in this section may not apply to this specific light.

TERMINOLOGY

OverDrive™ Light includes an integrated high-current strobe driver for complete LED light control.

Continuous Operation Light stays on continuously

Multi-Drive™ Combines continuous operation and OverDrive™ strobe (high-current strobe operation) modes into one easy-to-use light.

Built-In Driver The built-in driver allows full function without the need of an external driver.

Camera to Light Connecting the light directly to the camera, without the need for additional controllers or equipment

Polarizers Filters that reduce reflections on specular surfaces.

Diffuser Used to widen the angle of light emission, reduce reflections, and increase uniformity.

TYPES OF ILLUMINATION

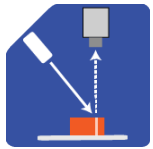

Projector

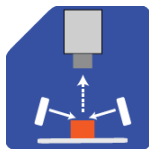

Dark Field

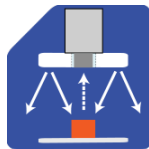

Radial

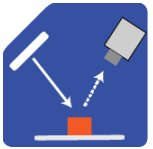

Bright Field

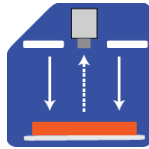

Direct

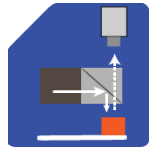

Axial

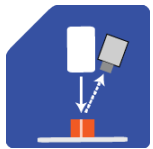

Line

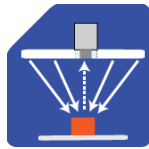

Diffuse Panel

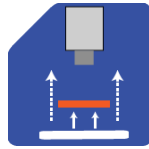

Backlight

COMMON COLOR/WAVELENGTHS LEGEND

Wavelength options range from 365 nm to 1550 nm.
Additional wavelengths available for many light families.

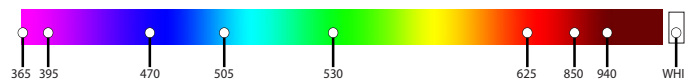

See Part Number section for **this light's** available standard wavelengths.



Shortwave infrared LEDs are available in 1050 nm, 1200 nm, 1300 nm, 1450 nm, and 1550 nm.

Check Part Number section to see if **this light** is available in SWIR wavelengths.