

LVS V275 Print Inspection System

Operations Manual



NOTE

- All rights reserved.
- No part of this publication may be reproduced, stored in a retrieval system, or transmitted, in any form, or by any means, mechanical, electronic, photocopying, recording, or otherwise, without the prior written permission of OMRON.
- No patent liability is assumed with respect to the use of the information contained herein. Moreover, because OMRON is constantly striving to improve its high-quality products, the information contained in this manual is subject to change without notice. Every precaution has been taken in the preparation of this manual. Nevertheless, OMRON assumes no responsibility for errors or omissions.
Neither is any liability assumed for damages resulting from the use of the information contained in this publication.

Trademarks

- Microsoft and Windows are trademarks of Microsoft Corporation.
- ODVA, CIP, CompoNet, DeviceNet, and EtherNet/IP are trademarks of ODVA.
- QR Code is a registered trademark of DENSO WAVE INCORPORATED.
Company names and product names in this document are the trademarks of their companies.

Copyrights

Microsoft product screen captures reprinted with permission from Microsoft Corporation.

Terms and Conditions Agreement

Warranty, Limitations of Liability

Warranties

● Exclusive Warranty

Omron's exclusive warranty is that the Products will be free from defects in materials and workmanship for a period of twelve months from the date of sale by Omron (or such other period expressed in writing by Omron). Omron disclaims all other warranties, express or implied.

● Limitations

OMRON MAKES NO WARRANTY OR REPRESENTATION, EXPRESS OR IMPLIED, ABOUT NON-INFRINGEMENT, MERCHANTABILITY OR FITNESS FOR A PARTICULAR PURPOSE OF THE PRODUCTS. BUYER ACKNOWLEDGES THAT IT ALONE HAS DETERMINED THAT THE PRODUCTS WILL SUITABLY MEET THE REQUIREMENTS OF THEIR INTENDED USE.

Omron further disclaims all warranties and responsibility of any type for claims or expenses based on infringement by the Products or otherwise of any intellectual property right.

● Buyer Remedy

Omron's sole obligation hereunder shall be, at Omron's election, to (i) replace (in the form originally shipped with Buyer responsible for labor charges for removal or replacement thereof) the non-complying Product, (ii) repair the non-complying Product, or (iii) repay or credit Buyer an amount equal to the purchase price of the non-complying Product; provided that in no event shall Omron be responsible for warranty, repair, indemnity or any other claims or expenses regarding the Products unless Omron's analysis confirms that the Products were properly handled, stored, installed and maintained and not subject to contamination, abuse, misuse or inappropriate modification. Return of any Products by Buyer must be approved in writing by Omron before shipment. Omron Companies shall not be liable for the suitability or unsuitability or the results from the use of Products in combination with any electrical or electronic components, circuits, system assemblies or any other materials or substances or environments. Any advice, recommendations or information given orally or in writing, are not to be construed as an amendment or addition to the above warranty.

See <http://www.omron.com/global/> or contact your Omron representative for published information.

Limitation on Liability, Etc.

OMRON COMPANIES SHALL NOT BE LIABLE FOR SPECIAL, INDIRECT, INCIDENTAL, OR CONSEQUENTIAL DAMAGES, LOSS OF PROFITS OR PRODUCTION OR COMMERCIAL LOSS IN ANY WAY CONNECTED WITH THE PRODUCTS, WHETHER SUCH CLAIM IS BASED IN CONTRACT, WARRANTY, NEGLIGENCE OR STRICT LIABILITY.

Further, in no event shall liability of Omron Companies exceed the individual price of the Product on which liability is asserted.

Application Considerations

Suitability of Use

Omron Companies shall not be responsible for conformity with any standards, codes or regulations which apply to the combination of the Product in the Buyer's application or use of the Product. At Buyer's request, Omron will provide applicable third party certification documents identifying ratings and limitations of use which apply to the Product. This information by itself is not sufficient for a complete determination of the suitability of the Product in combination with the end product, machine, system, or other application or use. Buyer shall be solely responsible for determining appropriateness of the particular Product with respect to Buyer's application, product or system. Buyer shall take application responsibility in all cases.

NEVER USE THE PRODUCT FOR AN APPLICATION INVOLVING SERIOUS RISK TO LIFE OR PROPERTY WITHOUT ENSURING THAT THE SYSTEM AS A WHOLE HAS BEEN DESIGNED TO ADDRESS THE RISKS, AND THAT THE OMRON PRODUCT(S) IS PROPERLY RATED AND INSTALLED FOR THE INTENDED USE WITHIN THE OVERALL EQUIPMENT OR SYSTEM.

Programmable Products

Omron Companies shall not be responsible for the user's programming of a programmable Product, or any consequence thereof.

Disclaimers

Performance Data

Data presented in Omron Company websites, catalogs and other materials is provided as a guide for the user in determining suitability and does not constitute a warranty. It may represent the result of Omron's test conditions, and the user must correlate it to actual application requirements. Actual performance is subject to the Omron's Warranty and Limitations of Liability.

Change in Specifications

Product specifications and accessories may be changed at any time based on improvements and other reasons. It is our practice to change part numbers when published ratings or features are changed, or when significant construction changes are made. However, some specifications of the Product may be changed without any notice. When in doubt, special part numbers may be assigned to fix or establish key specifications for your application. Please consult with your Omron's representative at any time to confirm actual specifications of purchased Product.

Errors and Omissions

Information presented by Omron Companies has been checked and is believed to be accurate; however, no responsibility is assumed for clerical, typographical or proofreading errors or omissions.

Missing Features or Limitations

Firewall Configuration Management

Currently the installer does not manage firewall configuration needed for remote UI clients. Using a UI remotely to access the server may require the server PC to be configured to allow bidirectional access to TCP ports 8080-8084.

Important Information



Due to continual product improvements, the product you receive may differ from the content outlined in this guide. Here is essential information for you to know about your V275 Print Inspection System:

- The V275 Print Inspection System will arrive at your site in specially designed shipping containers. Do not discard these containers in case you must ship or store the system for any reason. Failure to use these containers when returning your product to Omron Microscan will void the warranty.
- The V275 Print Inspection System supports 64-bit Windows® 7 SP1 or newer, Windows® 10, and Windows Server 2008 R2 SP1 or newer.
- The V275 Print Inspection System includes technologies covered under United States Patent # 8,939,368 B2.





Safety Precautions

Symbols and the meanings for safety precautions are described below:





In order for the product to be used safely, the following indications are used in this book to draw your attention to the cautions. The cautions with the indications describe the important contents for safety.



	<p>Indicates a potentially hazardous situation which, if not avoided, will result in minor or moderate injury, or may result in serious injury or death. Additionally, there may be significant property damage.</p>
	<p>Indicates a potentially hazardous situation which, if not avoided, may result in minor or moderate injury or in property damage.</p>

Meanings of Alert Symbols

	<p>General Prohibition Indicates general prohibitions, including warnings, for which there is no specific symbol.</p>
	<p>General Caution Indicates general cautions, including warnings, for which there is no specific symbol.</p>
	<p>Electrical Hazard Indicates the possible danger of electric shock under specific conditions.</p>
	<p>High Temperature Caution Indicates the possible danger of injury by high temperature under specific conditions.</p>

Alert Statements in this Manual

	<p>General Caution This product must be used according to this manual or Instruction sheet. Failure to observe this may result in impairment of functions and performance of the product.</p>
	<p>General Prohibition This product is not designed or rated for ensuring safety of persons. Do not use it for such purposes.</p>
	<p>General Caution When using equipment that is connected to an AC power source including an AC adapter or Power Over Ethernet (PoE) injector, use it within the rated voltage range. Usage with a voltage higher than what it is rated for may cause serious personal injury due to electric shock, or serious physical damage due to fire or equipment failure. Do not touch any part of the device while in operation, or immediately after turning OFF the power.</p>
	<p>General Eye Caution Since the imaging device assembly that is part of this product emits a visible light that may have an adverse effect on the eyes, do not stare directly into the light emitted from the LED. If a specular object is used, take care not to allow reflected light to enter your eyes.</p>
	<p>General Caution Please take external safety measures so that the system as a whole remains safe even if this product malfunctions or has an error condition caused by external factors. An abnormal operation may result in serious accident.</p>

	General Caution Please establish appropriate processes to ensure safety in the case of any abnormal operation of this equipment. An abnormal operation may result in a serious accident.
	High Temperature Caution Danger of burns. Do not touch the printhead while the printer is running or just after power is turned OFF, since it remains extremely hot.

Precautions for Safe Use

Condition of the Fitness of OMRON Products

Omron products are designed and manufactured as general-purpose products for use in general industrial applications. They are not intended to be used in the following critical applications. If you are using Omron products in the following applications, Omron shall not provide any warranty for such Omron products unless otherwise specifically agreed or unless the specific applications are intended by Omron.

- (a) Applications with stringent safety requirements, including but not limited to nuclear power control equipment, combustion equipment, aerospace equipment, railway equipment, elevator/lift equipment, amusement park equipment, medical equipment, safety devices, and other applications that could cause danger/harm to people's body and life.
- (b) Applications that require high reliability, including but not limited to supply systems for gas, water and electricity, etc., 24-hour continuous operating systems, financial settlement systems, and other applications that handle rights and property.
- (c) Applications under severe conditions or in severe environments, including but not limited to outdoor equipment, equipment exposed to chemical contamination, equipment exposed to electromagnetic interference, and equipment exposed to vibration and shocks.
- (d) Applications under conditions and environment are not described in specifications.

Note: The above is part of the Terms and Conditions Agreement. Please use carefully read the contents of the guarantee and disclaimers described in our latest version of the catalog, data sheets and manuals.

Installation Environment

- Do not use this product in areas where flammable or explosive gases are present.
- Be careful when unpacking this product. Injury may occur if the unit falls and strikes a person.
- Do not install the product close to high-voltage devices and power devices in order to secure the safety of operation and maintenance.

Power Supply and Wiring

- Make sure to use the product with the power supply voltage specified by this manual.
- When using equipment that is connected to an AC power source such as an AC adapter or Power Over Ethernet (PoE) injector, use it within the rated voltage range. Usage with a voltage higher than what it is rated for may cause serious personal injury due to electric shock, or serious physical damage due to fire or equipment failure. Do not touch any part of the device while in operation, or immediately after turning OFF the power.

Other

- Use only the cables designed specifically for the V275 Print Inspection System. Use of other products may result in malfunction or damage of the printer.
- Always turn OFF the power of the printer and disconnect power to the V275 Print and Inspection Hardware before connecting or disconnecting a cable. Connecting the cable with power supplied may result in damage of the reader or peripheral devices.
- Do not apply torsion stress to the cable. It may damage the cable.
- Secure the minimum bending radius of the cable. Otherwise the cable may be damaged.
- Do not attempt to dismantle, repair, or modify the product.
- When disposing of the product, recycle or treat as industrial waste.
- Should you notice any abnormalities, immediately stop use, turn OFF the power supply, and contact your OMRON representative.
- While the power is ON or immediately after the power is turned OFF, certain components may be hot. Avoid touching hot surfaces.
- Do not drop the product nor apply excessive vibration or shock to the product. Doing so will cause malfunction.

Precautions for Correct Use

Install and store the product in a location that meets the following conditions:

- Surrounding temperature of 0 to +40°C (-50 to +75°C in storage)
- No rapid changes in temperature (place where dew does not form)
- Relative humidity of between 5 to 85%
- No presence of corrosive or flammable gases
- Place free of dust, salts and iron particles
- Place free of vibration and shock
- Place out of direct sunlight
- Place where it will not come into contact with water, oils or chemicals
- Place not affected by strong electro-magnetic waves
- Place not near to high-voltage, or high-power equipment
- For good heat dissipation, keep at least 3" space between this unit and other equipment.
- Do not install the product immediately above significant heat sources, such as heaters, transformers, or large-capacity resistors.
- Do not let the ambient temperature exceed the operating temperature range.
- Provide a forced-air fan cooling or air conditioning if the ambient temperature is near the upper range of operating temperature range so that the ambient temperature never exceeds the upper range of operating temperature range.
- Do not install the product in a cabinet containing high-voltage equipment.
- Do not install the reader within 200 mm of power cables.

Regulations and Standards

Conformance to EC/EU Directives

This regulation applies to V275 Print Inspection System.

- This product is in compliance with all applicable directives: 2014/53/EU and 2011/65/EU.
- This product complies with EC/EU Directives. EMC-related performance of the OMRON devices that comply with EC/EU Directives will vary depending on the configuration, wiring, and other conditions of the equipment or control panel on which the OMRON devices are installed.
- The customer must, therefore, perform the final check to confirm that devices and the overall machine conform to EMC standards.

Conformance to UL Standards

This product complies with UL Standards.

- UL60950-1 2nd edition, 2019-05-09

Conformance to Korean Standards

한국 (Korea)

이 기기는 가정용 (B 급) 전자파 적합기기로서 주로 가정에서 사용하는 것을 목적으로 하며, 모든 지역에서 사용할 수 있습니다.

The equipment is for home use (Class B) and has acquired electromagnetic conformity registration, so it can be used not only in residential area but other areas as well.

이 기기는 가정용 (B 급) 전자파 적합기기로서 주로 가정에서 사용하는 것을 목적으로 하며, 모든 지역에서 사용할 수 있습니다.

This radio device is not allowed to be used for human safety since it has possibility of radio interference during operation.

Radio Frequency Interference Requirements

United States: FCC

This device complies with Part 15 rules. Operation is subject to the following two conditions:

- This device may not cause harmful interference, and
- This device must accept any interference received, including interference that may cause undesired operation.

This equipment has been tested and found to comply with the limits for Class B Digital Devices, pursuant to Part 15 of the FCC Rules. These limits are designed to provide reasonable protection against harmful interference when the equipment is operated in a residential environment. This equipment generates, uses, and can radiate radio frequency energy, and, if not installed and used in accordance with the product manuals, may cause harmful interference to radio communications.

However, there is no guarantee that interference will not occur in a particular installation. If this equipment does cause harmful interference to radio or television reception, the user is encouraged to do one or more of the following measures:

- Reorient or relocate the receiving antenna.
- Increase the separation between the equipment and receiver.
- Connect the equipment into an outlet on a circuit different from that to which the receiver is connected.
- Consult the dealer or an experienced RF service technician for help.

● Important

- (a) The radio must be installed with a minimum 20 cm separation between the user and the antenna.
- (b) The radio must not be co-located or used in simultaneous transmitting condition with another radio.
- (c) The host system shall have a label to indicate that the system contains a certified module.
- (d) An example is "Contains FCC ID: XXXXXX-XXXXXXXXXX, IC ID: XXXXX-XXXXXXXX".
- (e) The radio is a Bluetooth radio that operates in the 2.4 GHz frequency range.

The user is cautioned that any changes or modifications not expressly approved by Zebra Technologies could void the user's authority to operate the equipment. To ensure compliance, this printer must be used with fully shielded communication cables.

Canada

DOC Compliance

Cet appareil numérique de la classe B est conforme à la norme NMB-003 du Canada. This Class B digital apparatus complies with Canadian ICES-003.

Industry Canada (IC) Warning

Le présent appareil est conforme aux CNR d'Industrie Canada applicables aux appareils radio exempts de licence. L'exploitation est autorisée aux deux conditions suivantes : (1) l'appareil ne doit pas produire de brouillage, et (2) l'utilisateur de l'appareil doit accepter tout brouillage radioélectrique subi, même si le brouillage est susceptible d'en compromettre le fonctionnement.

This device complies with the Industry Canada license-exempt RSS standard(s). Operation is subject to the following two conditions: 1) This device may not cause interference, 2) This device must accept any interference, including interference that may cause undesired operation of the device.

Revision History

The manual's part number and revision letter appear on the first and last pages.

Part Number	84-9310123-02 Rev A
--------------------	----------------------------

Revision 

Revision	Date	Revised Content
A	August 2020	First publication.

Table of Contents

Section 1 Getting Started

1-1	Introduction to the V275 Print Inspection System.....	1-2
1-2	Hardware Component Identification.....	1-3
1-3	Identifying Printer Components.....	1-4

Section 2 Hardware Installation

2-1	Unpacking the V275 Print Inspection System.....	2-2
2-1-1	Components Shipped with the V275 Print Inspection System.....	2-2
2-1-2	Shipping Damage.....	2-3
2-1-3	Software and Support Files on the V275 USB Drive.....	2-3
2-1-4	Items Not Included with the Printer (Must Be Supplied by User).....	2-3
2-2	System Setup.....	2-4
2-2-1	Network Configuration.....	2-4
2-3	Hardware Setup.....	2-6
2-3-1	Connecting System Hardware.....	2-6

Section 3 Network Configuration

3-1	Overview of V275 Network Configuration.....	3-2
3-2	Configuring the NIC(s) on the V275 Print Inspection Server.....	3-3
3-2-1	Configuring IP Addresses for the V275 Server NICs.....	3-6
3-2	Configuring the V275 Imaging Device Network Interface.....	3-7
3-3-1	Configuring a Static IP Address on the V275 Imaging Device.....	3-7
3-3-2	Setting the V275 Imaging Device to a Persistent IP Address.....	3-10

Section 4 Hardware Configuration

4-1	Configuring V275 Printer Hardware.....	4-2
4-1-1	ZT6x0 Printer Configuration.....	4-2
4-1-2	General Settings.....	4-2
4-1-3	Applicator Settings.....	4-2
4-1-4	Energy Star Settings.....	4-3
4-2	Loading Media for V275 Hardware.....	4-4
4-2-1	Media Loading When Front-Ejecting or Tearing Off Labels.....	4-4
4-2-2	Media Loading When Peeling Labels.....	4-7
4-2-3	Media Loading When Rewinding Labels.....	4-12
4-2-4	Loading the Ribbon.....	4-16

Section 5 Software Installation

5-1	V275 Software Overview.....	5-2
5-2	Operating System Requirements.....	5-2
5-3	Prerequisites.....	5-2
5-4	Installing V275 Software.....	5-4

Section 6 V275 User Interface

6-1 V275 User Interface Overview	6-2
6-1-1 Main View and Navigation	6-2
6-1-2 Attached Devices.....	6-3
6-1-3 Attached Devices Panel	6-3
6-1-4 Using a Simulation Device.....	6-4
6-1-5 Advanced Session Configuration	6-5
6-1-6 Device Status and Template Management	6-5

Section 7 System Administration

7-1 Accounts and Permissions	7-2
7-1-1 Administering User Accounts	7-2
7-1-2 Adding a User.....	7-3
7-1-3 Removing or Modifying a User	7-4
7-1-4 User Permissions	7-5
7-1-5 Permission Enforcement	7-5
7-1-6 Active Directory Configuration.....	7-5
7-2 Language Selection.....	7-6
7-3 Peel and Present.....	7-7

Section 8 Calibration

8-1 Calibrating the V275 Print Inspection System	8-2
8-1-1 Calibration Process	8-2

Section 9 Inspection Templates

9-1 Management and Storage	9-2
9-2 Template Basics	9-3
9-2-1 Templates.....	9-3
9-2-2 Inspection Regions.....	9-3
9-3 Creating Templates	9-4
9-3-1 Creating a New Template.....	9-4
9-4 Label Inspection Synchronization	9-5
9-4-1 Synchronization Overview	9-5
9-4-2 Placing the Synchronization Region.....	9-6
9-5 Auto Setup	9-8
9-6 Edit Screen Components.....	9-8
9-7 Inspecting Barcodes	9-9
9-7-1 Verify 1D.....	9-9
9-7-2 Verify 2D.....	9-11
9-7-3 GS1 / Quality Specification.....	9-12
9-7-4 Barcode Grading	9-14
9-8 OCR and OCV	9-15
9-8-1 Font Selection.....	9-15
9-8-2 Read Mask and Touch Mode	9-16
9-8-3 Preprocessing Options	9-17

9-8-4	Font Editor	9-17
9-8-5	OCV	9-20
9-9	Data Matching	9-21
9-10	Blemish Inspection.....	9-24
9-10-1	Golden Image	9-24
9-10-1	Adding / Re-Sizing a Blemish Region.....	9-24
9-10-2	Blemish Editor	9-26
9-10-3	Layers	9-27
9-10-4	Tools.....	9-27
9-10-5	Clearing Layer	9-29
9-10-6	Undo / Redo	9-29
9-10-7	Blemish Parameters – Training Settings	9-29
9-11	Alarms / Outputs.....	9-30
9-12	Live Results	9-31
9-13	Editing	9-32
9-13-1	Reviewing Read Errors.....	9-32

Section 10 Run Mode

10-1	Run Mode	10-2
10-1-1	Panel Definitions.....	10-2
10-1-2	Failed Label Handling.....	10-3

Section 11 Analyze (Log Viewer)

11-1	Run Ledger.....	11-2
11-1-1	Individual Run Logs	11-2
11-1-2	Viewing Results	11-3
11-1-3	Data Exporting: PDF Reports	11-4
11-1-4	Data Exporting: Raw Data Export.....	11-5

Section 12 Audit Trail

12-1	Audit Trail Database	12-2
-------------	-----------------------------------	-------------

Appendices

Appendix A:	System Specifications.....	A-1
Appendix B:	Ordering Information.....	B-1
Appendix C:	Preventive Maintenance.....	C-1
Appendix D:	Importing LVS-7510 Templates.....	D-1
Appendix E:	V275 Service Viewer	E-1
Appendix F:	Tips and Troubleshooting	F-1
Appendix G:	Using Active Directory	G-1



1

Getting Started

This section provides an introduction to the V275 Print Inspection System.

1-1 Introduction to the V275 Print Inspection System	1-2
1-2 Hardware Component Identification	1-3
1-3 Identifying Printer Components	1-4

1-1 Introduction to the V275 Print Inspection System

The V275 Print Inspection System enables organizations to print labels that meet their quality requirements. The V275 allows inspection of every label printed, ensuring that every label meets the quality needs of the organization. The benefits of the The V275 system include:

- Allows organizations to meet regulatory requirements for quality barcodes.
- Allows organizations to ensure labels are not the cause of product being delayed by customs agencies.
- Eliminates poor-quality labels as the cause of returns and chargebacks from customers.
- Supports brand image by ensuring crisp, readable, zero-defect labels on products and packaging.

The V275 system supports printing on thermal transfer or direct thermal labels up to 6.6 inches / 168 mm wide. The system is compliant with the ISO/IEC 15426 standard for both 1D and 2D symbol verification. It can detect cosmetic errors in graphic elements of the label and can recognize Latin characters and match them with predefined or variable values.

The V275 system consists of hardware and software components. The major elements of a V275 Print Inspection System are:

- **V275 Hardware:** This is the physical embodiment of the system. It consists of a line-scan imaging device, printed circuit boards, image capture firmware and related hardware integrated into a Zebra ZT6x0 printer.
 - This documentation may refer to two hardware subsystems:
 - **Printer Hardware** (or, simply, the printer). This is also referred to as a node in the software instructions.
 - **V275 Imaging Device:** The V275 Print Inspection System includes the **V275 Imaging Device** as well as various other components that are integrated into the overall printer chassis.
 - The V275 Imaging Device is a component of the V275 Print Inspection System. The Imaging Device is responsible for capturing an image of the label as it exits the printer.
- **V275 Print Inspection Server:** The Print Inspection Server is the nucleus of the system. The Print Inspection Software is installed and executes as a service on a customer-supplied computer and communicates with the Print Inspection Hardware over dedicated Gigabit Ethernet ports. The V275 Print Inspection Server analyzes image data received from the Print Inspection Hardware to determine if it meets the specified quality standards.

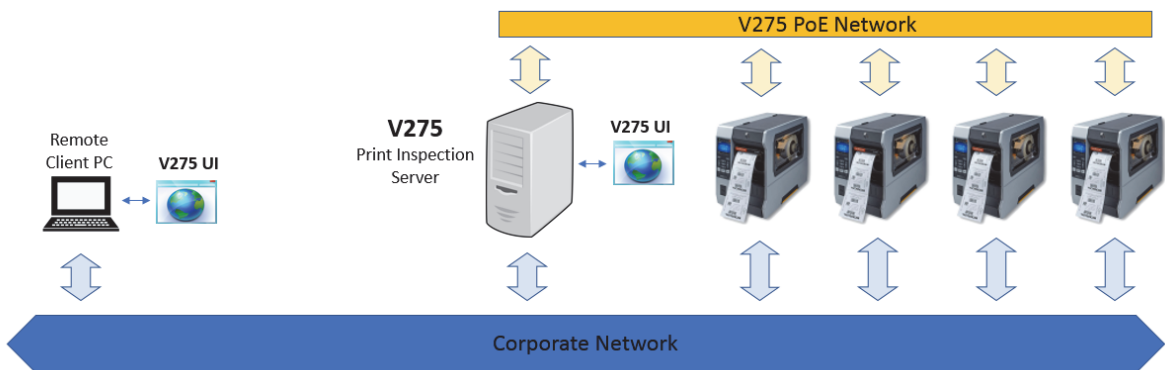

1-2 Hardware Component Identification

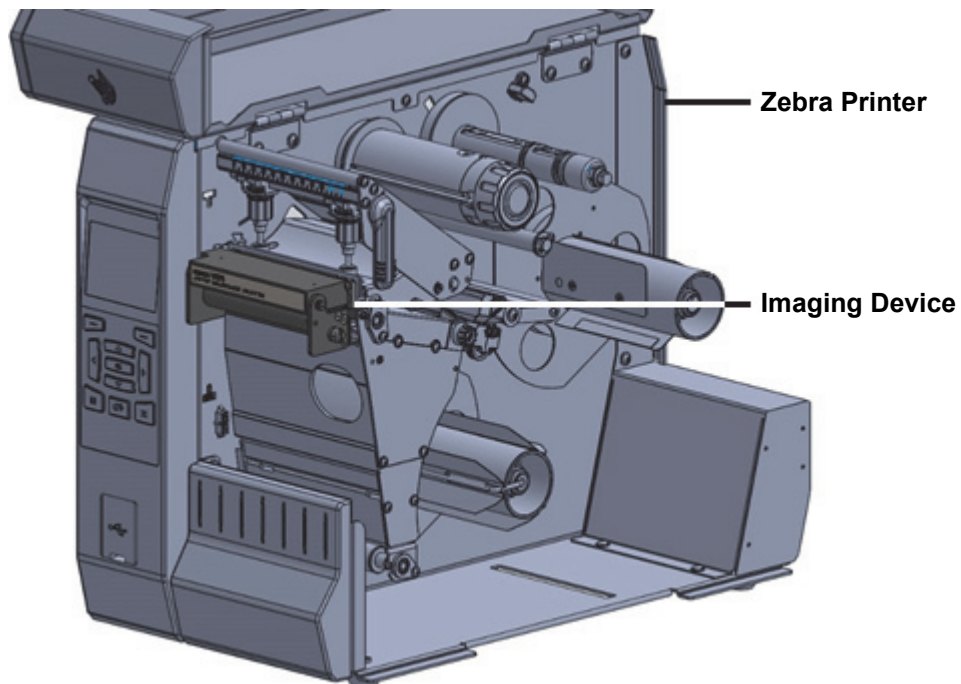

Side View with Printer Door Open

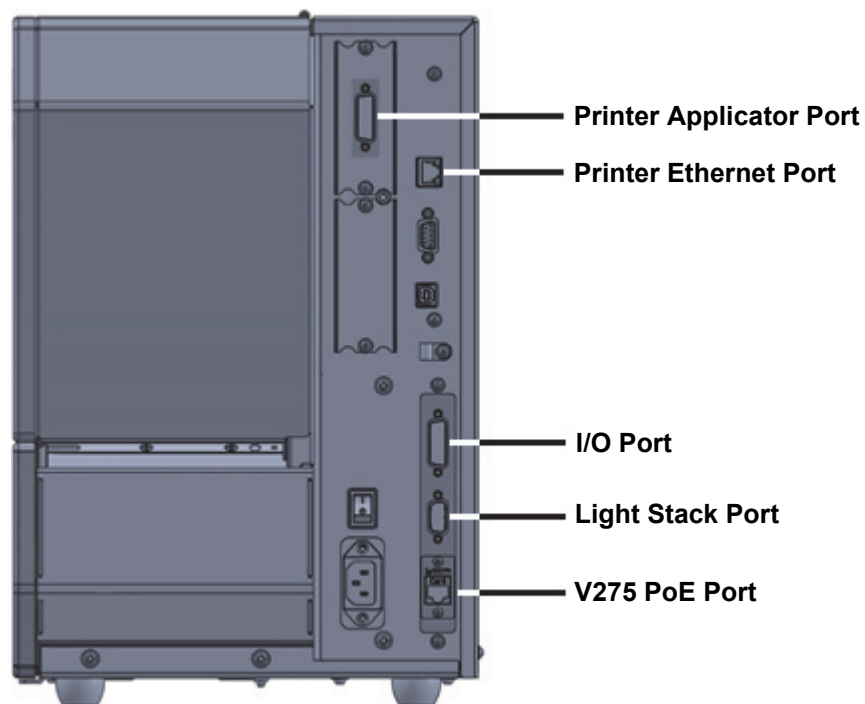

Rear View

Note: The V275 I/O Port, V275 Light Stack Port and V275 PoE Port make up the physical interfaces to the V275 Imaging Device, while the Printer Applicator Port and Printer Ethernet Port make up the physical interfaces to the printer.

1-3 Identifying Printer Components

Refer to the Zebra printer documentation to familiarize yourself with the components of the V275 Print Quality Inspection System.

2

Hardware Installation

This section describes the physical components of the V275 Print Inspection System and explains the basic process of installing those components in an application.

2-1	Unpacking the V275 Print Inspection System	2-2
2-1-1	Components Shipped with the V275 Print Inspection System	2-2
2-1-2	Shipping Damage	2-3
2-1-3	Software and Support Files on the V275 USB Drive	2-3
2-1-4	Items Not Included with the Printer (Must Be Supplied by User)	2-3
2-2	System Setup	2-4
2-2-1	Network Configuration	2-4
2-3	Hardware Setup	2-6
2-3-1	Connecting System Hardware	2-6





2-1 Unpacking the V275 Print Inspection System

- 1** Immediately unpack V275 Print Inspection System and inspect for shipping damage. See **Shipping Damage** for more information.
- 2** Check all exterior surfaces.
- 3** Verify that you have all of the parts that should have been shipped with the V275 Print Inspection System.
- 4** Set the Zebra printer up at the location where you want it placed, raise the Zebra printer media door, and then inspect the media compartment for damage to components.
- 5** Save all packing materials in case you need to return the V275 Print Inspection System for servicing.



CAUTION: The V275 Print Inspection System is heavy. Removing the unit from the packing material and installing it in the intended operating environment requires two people.

2-1-1 Components Shipped with the V275 Print Inspection System

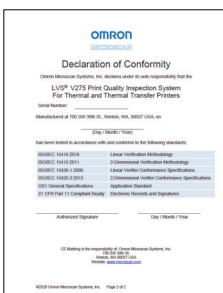
Zebra ZT6x0 Hardware with Integrated Print Inspection Components	
A/C Power Cable (U.S.)	N/A
Loopback Cable (DB15-M to DP15-F)	
V275 USB Flash Drive	
V275 Calibration Conformance Test Card*	 <p style="text-align: center;">OR</p> <p style="text-align: center;">ZT610 Card ZT620 Card</p>
V275 Declaration of Conformity	

CE Compliance Sheet	
Read Me First Insert	

*There are two versions of the V275 Calibration Conformance Test Card: One for V275 systems with ZT610 printer hardware, and one for V275 systems with ZT620 printer hardware.

2-1-2 Shipping Damage

If you discover shipping damage upon inspection, do the following:

- 1** Immediately notify the shipping company and file a damage report.
- 2** Keep all packaging material for shipping company inspection.
- 3** Notify your Omron Microscan representative.

2-1-3 Software and Support Files on the V275 USB Drive

- LVS V275 Print Inspection System Operations Manual (this document)
- LVS V275 Print Inspection System Software Installer

2-1-4 Items Not Included with the Printer (Must Be Supplied by User)

- Computer to host the V275 Server
Recommended server PC specifications:
 - **OS:** Windows® 10 64-Bit
 - **CPU:** Quad Core > 2.4 GHz
 - **RAM:** 8 GB minimum
- Computer for accessing V275 Client – This can be the server computer or a separate PC or tablet. V275 Client computer must include a web browser that supports WebGL. V275 Client computer hardware must also support WebGL.
 - Fully tested browsers: Google Chrome™ (78.0.3904.97 or later)
 - Browsers must support WebGL. The following are not fully tested: Firefox 4+, Opera 12+, Safari 5.1+, Internet Explorer 11+, and Microsoft® Edge build 10240+
- 3 or more Ethernet cables:
 - 1 Cat 5 or better cable for connecting the V275 Server computer to the corporate network
 - 1 Cat 6 or better cable for connecting the V275 Server computer to the V275 Print Inspection Hardware PoE port
 - If a GigE PoE switch is being used, 1 Cat 6 or better cable for connecting the V275 Server computer to the GigE PoE switch and 1 Cat 6 or better cable for connecting the GigE PoE switch to each V275 Print Inspection Hardware unit PoE port
 - 1 Cat 5 or better cable for connecting printer Ethernet port to network or computer hosting the label server
- Gigabit Power over Ethernet (PoE) switch or a PoE injector or a V275 Server computer with PoE-enabled Network Interface Card(s) (NICs).

2-2 System Setup

The V275 Print Inspection System can be visualized using the following diagram. The V275 Software is installed on a server PC shown below as the V275 Print Inspection Server. A single V275 Server can connect and operate up to four V275 Imaging Devices through a dedicated high bandwidth GigE PoE network. This device network is a physically separate network that provides power and a direct high bandwidth interface from the server to the inspecting imaging devices. This network needs to support jumbo frames up to 9014 bytes. The Corporate Network provides access to the printer(s) for network printing and to the V275 Server for remote client PCs wishing to run the V275 user interface remotely. This user interface, V275 UI, runs in a supported browser either directly on the V275 Print Inspection Server, or bandwidth permitting, on a client device connected to the corporate network.

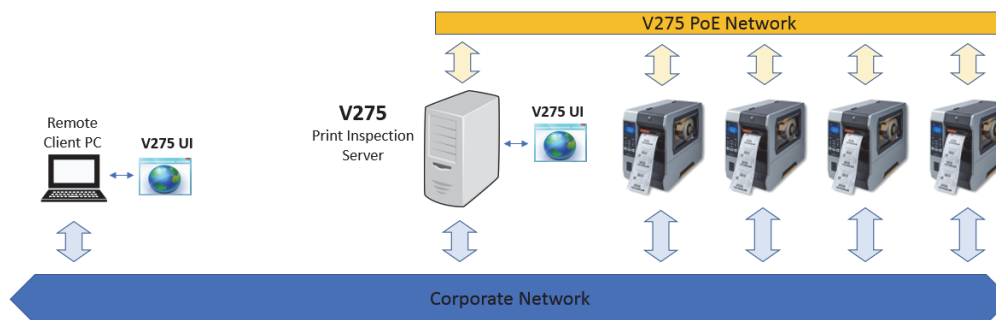

2-2-1 Network Configuration

To prevent system errors, the V275 Print Inspection Hardware should have dedicated PoE GigE ports on the V275 Server computer. The V275 Server computer should be designed to run applications of this type. There are many industrial PCs designed for applications of this type. There are also PoE Network Interface Cards (NICs) that can be installed on standard windows server computers.

Optimal Topology (Recommended)

Optimal Topology provides the most reliable performance, especially when running multiple V275 Print Inspection systems from a single server. Each V275 Imaging Device has its own direct connection to a NIC on the server as well as being separate from the corporate network. The recommended configuration is:

- Up to 4 units
- 1 V275 Server
- 1 or more V275 Client(s)
- Dedicated V275 Server PC with 4-Port PoE NIC Card

The V275 Print Inspection Hardware units are directly connected to the GigE PoE NICs in the V275 Server computer. The printer Ethernet port connects to label management software on a separate network, which is depicted as the Corporate Network in the diagram below.

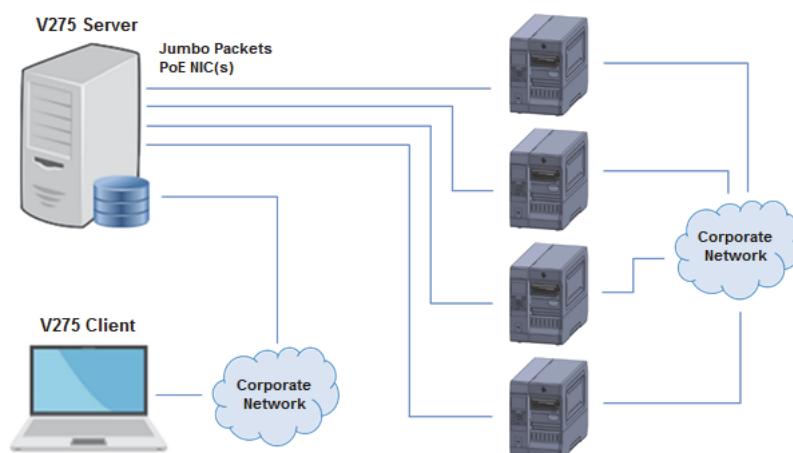

Dual NIC Topology

A Dual NIC Topology performs well (as shown below) if controlling a single or dual Print Inspection System. This configuration provides adequate performance only when controlling up to two V275 units, but should not be used with more than two systems.

Note: While this Dual NIC configuration is a suggested configuration that may be useful in some situations when you cannot implement the Optimal Configuration, it could introduce bandwidth and latency problems for the V275 Print Inspection System.

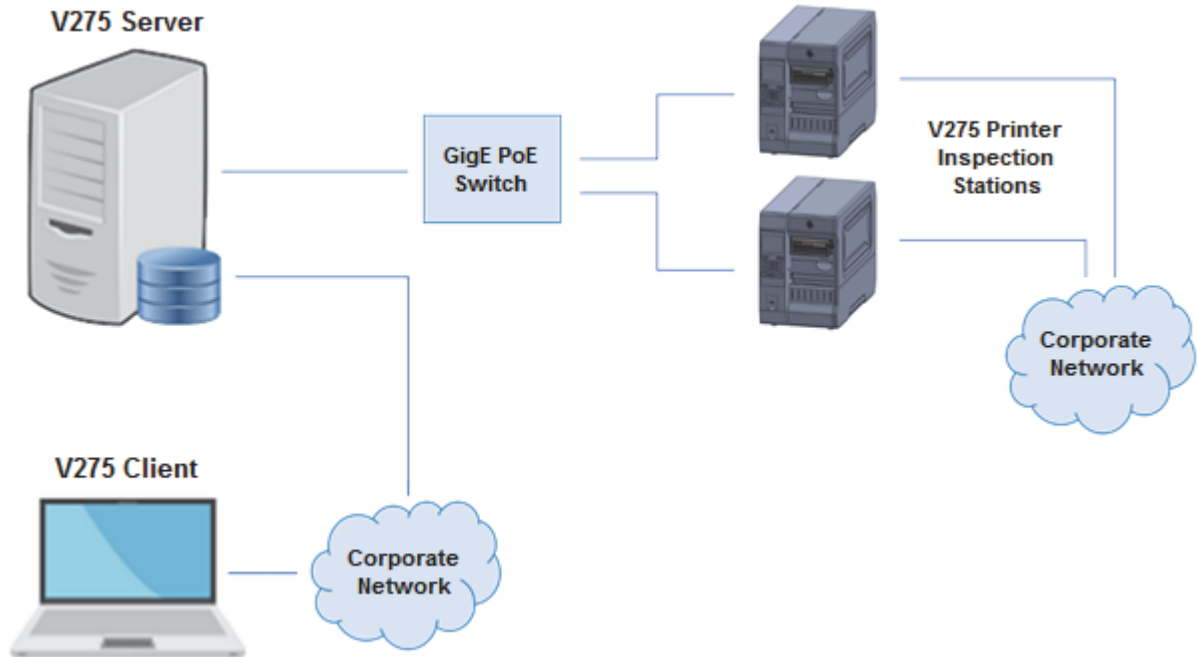

In this configuration, the suggested equipment and connectivity are:

- Up to 2 V275 Print Inspection Hardware units
- 1 V275 Server
- 1 or 2 V275 Client(s)
- 1 GigE PoE Switch

The V275 units are directly connected to the GigE PoE switch, which communicates to the V275 Server computer over a single GigE interface. The printer Ethernet port(s) connect to label management software on a separate network, which is depicted as the Corporate Network in the diagram above.

● Bandwidth and Potential Network Performance Issues

Dual NIC configuration may be useful when you cannot implement the Optimal Configuration. However, it could introduce bandwidth and latency problems for the V275 Print Inspection System.

The Optimal Topology works best because the V275 Print Inspection Hardware units are directly connected to the GigE PoE NICs in the V275 Server computer. The printer Ethernet port connects to label management software on a separate network, which is depicted as the Corporate Network.

2-3 Hardware Setup

2-3-1 Connecting System Hardware

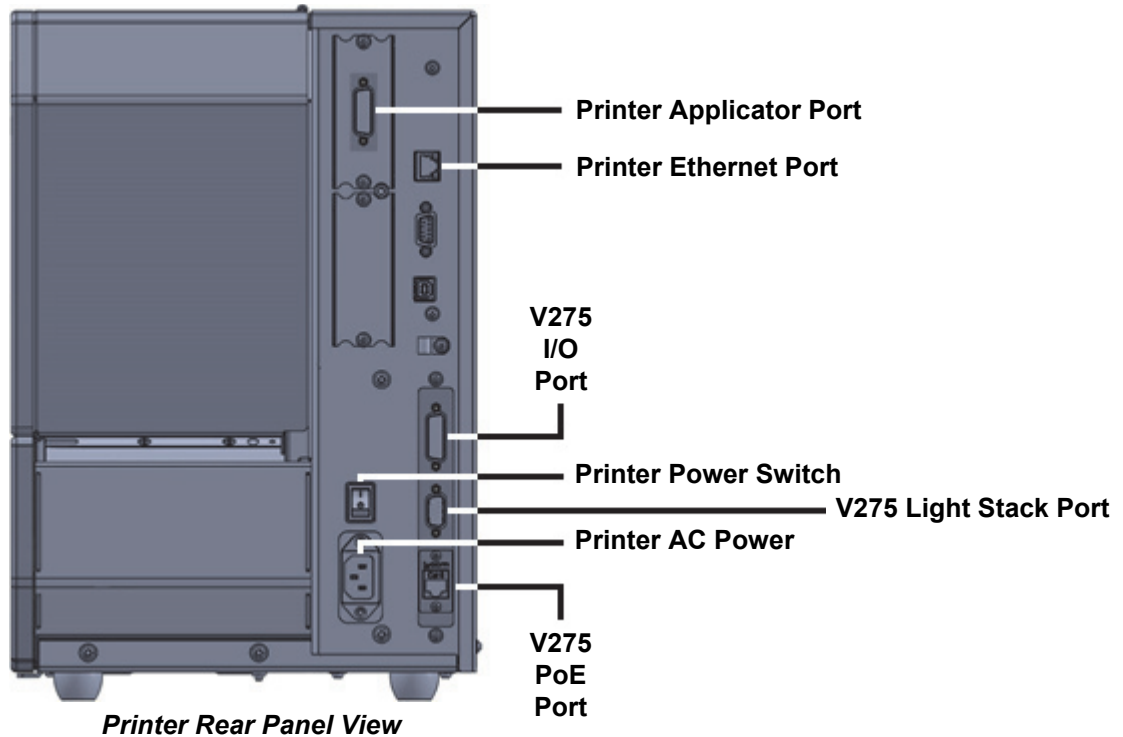

- 1 Connect the **Loopback Cable** between the **Printer Applicator Port** and the **V275 I/O Port**. There is only one orientation in which the Loopback Cable can be connected.
- 2 Tighten the connectors on each end using the connector screws. Note that the **Printer Applicator Port** may be mounted in either the upper or lower bay. In this image, it is mounted in the upper bay. The Loopback Cable is designed to reach either position.

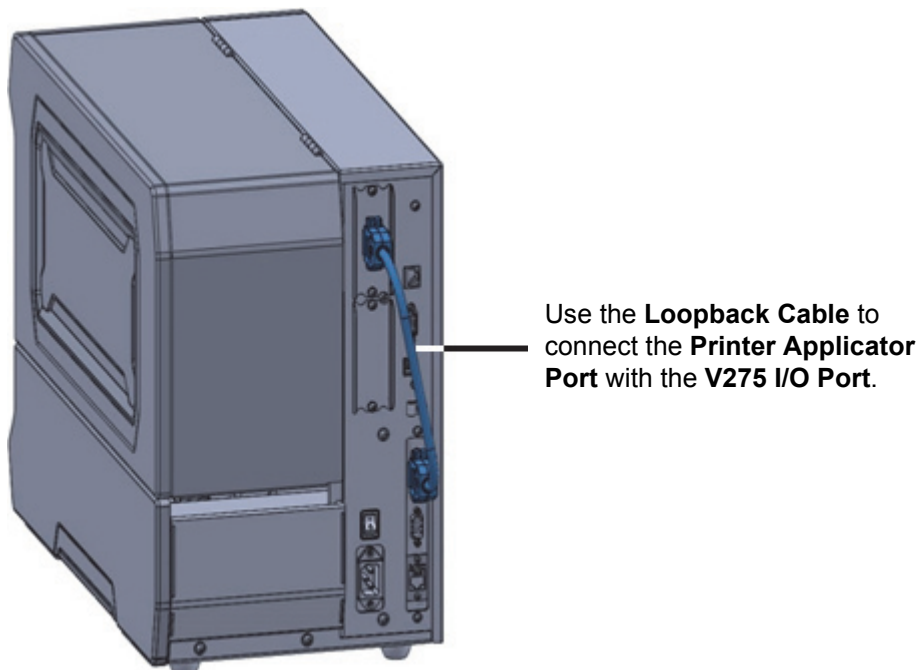

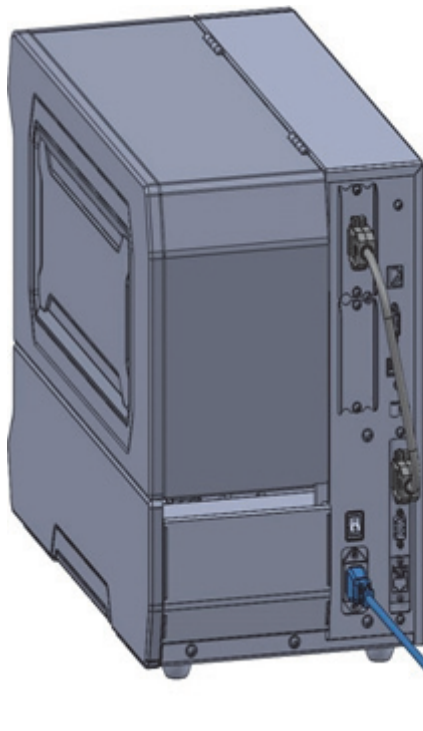
3 Connect the printer's **power cable**.

Connect the **Printer AC Power** port to an AC power outlet via the printer's **power cable**.

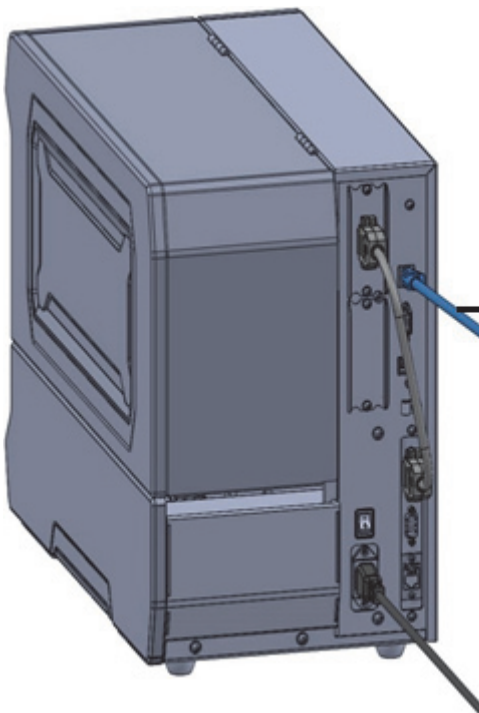
4 Connect the printer network **Ethernet cable** to the **Printer Ethernet Port**.

Connect the printer network's **Ethernet cable** (Cat 5 or better) to the **Printer Ethernet Port**.

- 5** Connect the optional **light stack** to the **V275 Light Stack Port**, and then tighten the cable using the connector screws.

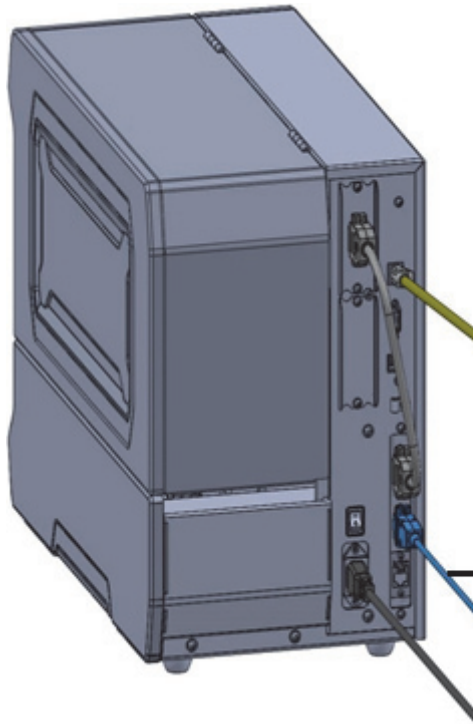

Connect a **light stack** to the **V275 Light Stack Port** if required by the application.

- 6** Plug in the attached 24V power supply to a 120V supply.

- 7** Power-on the printer using the **Printer Power Switch**.

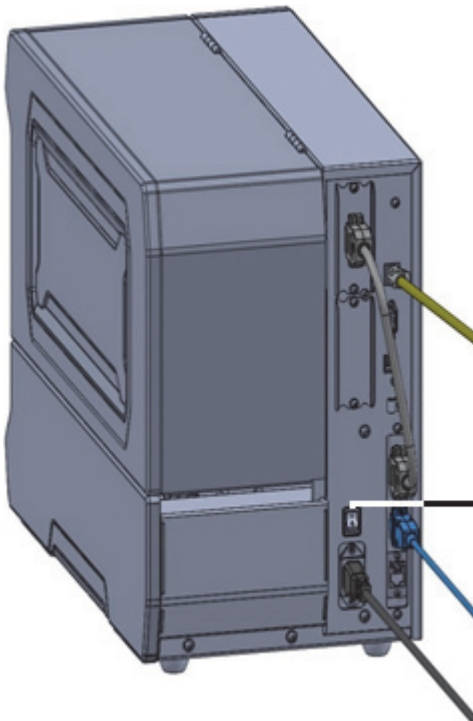

Power-on the printer.

- 8 Connect a **shielded Cat 6 Ethernet cable** to the **V275 PoE port**. The other end of the cable will connect to a PoE port on the V275 Server computer. If a light stack has been connected, it will cycle through a counting sequence indicating the system is operational.

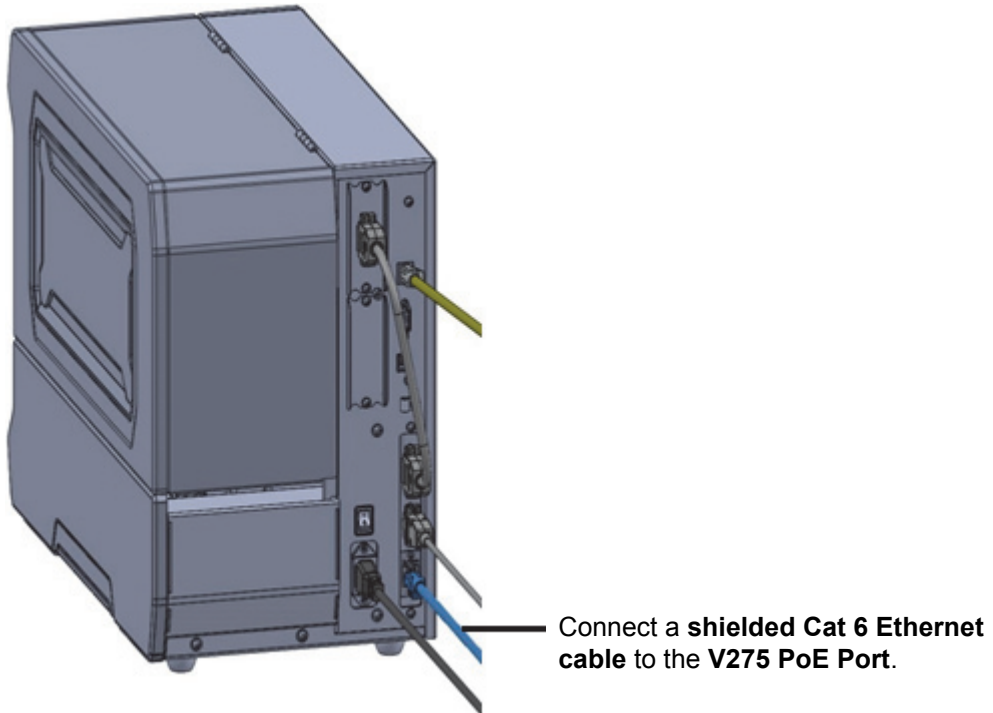

3

Network Configuration

This section explains how to set up and configure the V275 Print Inspection System on a network as required by your application.

3-1	Overview of V275 Network Configuration.	3-2
3-2	Configuring the NIC(s) on the V275 Print Inspection Server	3-3
3-2-1	Configuring IP Addresses for the V275 Server NICs	3-6
3-3	Configuring the V275 Imaging Device Network Interface	3-7
3-3-1	Configuring a Static IP Address on the V275 Imaging Device	3-7
3-3-2	Setting the V275 Imaging Device to a Persistent IP Address.	3-10

3-1 Overview of V275 Network Configuration

This section assumes a physical network configuration as specified in the Optimal Topology section. Print inspection network traffic will reside on a dedicated network that is separate from the corporate network. All endpoints in this network must be configured to use static IP addresses. All network components on the print inspection network must also be configured to allow jumbo packets and the number of “receive buffers” should be maximized.

In this manual, our example network will use the 192.168.yyy.xxx subnets. We will configure the first V275 Server NIC at 192.168.1.1 and the corresponding V275 Print Inspection Engine at 192.168.1.2. Additional NIC/V275 Print Inspection Engine pairs will increase the third octet by 1. For example, the second V275 Server NIC will be at 192.168.2.1 and the corresponding V275 Print Inspection Engine will be at 192.168.2.2.

V275 Print Inspection Hardware Device	NIC	Where to Configure Each Device
V275 Server NIC 1	192.168.1.1	Windows®
V275 Hardware Unit 1	192.168.1.2	eBUS Player
V275 Server NIC 2	192.168.2.1	Windows®
V275 Hardware Unit 2	192.168.2.2	eBUS Player
V275 Server NIC 3	192.168.3.1	Windows®
V275 Hardware Unit 3	192.168.3.2	eBUS Player
V275 Server NIC 4	192.168.4.1	Windows®
V275 Hardware Unit 4	192.168.4.2	eBUS Player

3-2 Configuring the NIC(s) on the V275 Print Inspection Server

For each NIC (Network Interface Card) connected to a V275 Print Inspection Hardware device, you will need to configure the network adapter properties to:

- Disable power saving;
- Use jumbo packets;
- Maximize the size of the receive buffers;
- Use a static IP address.

1 Go to **Control Panel > All Control Panel Items > Network and Sharing Center**.



2 Click **Change adapter settings**.

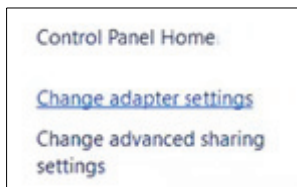

3 Right-click on the **Ethernet** device to select the Ethernet adapter as shown by the yellow-highlighted example below.

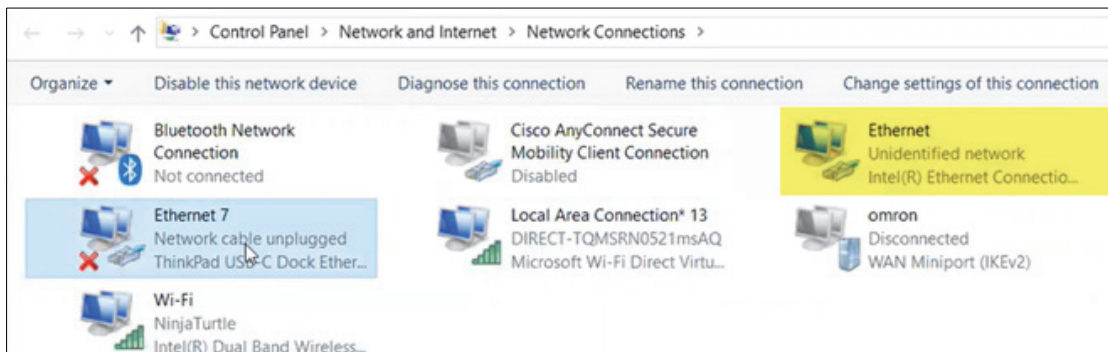

4 Select **Properties** from the **Network Connections** dropdown menu.

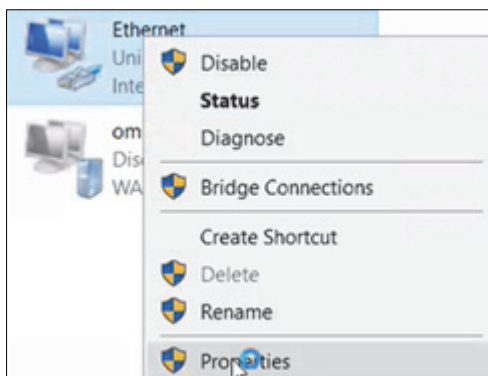

- 5** When the **Ethernet Properties** dialog opens, click **Configure**.

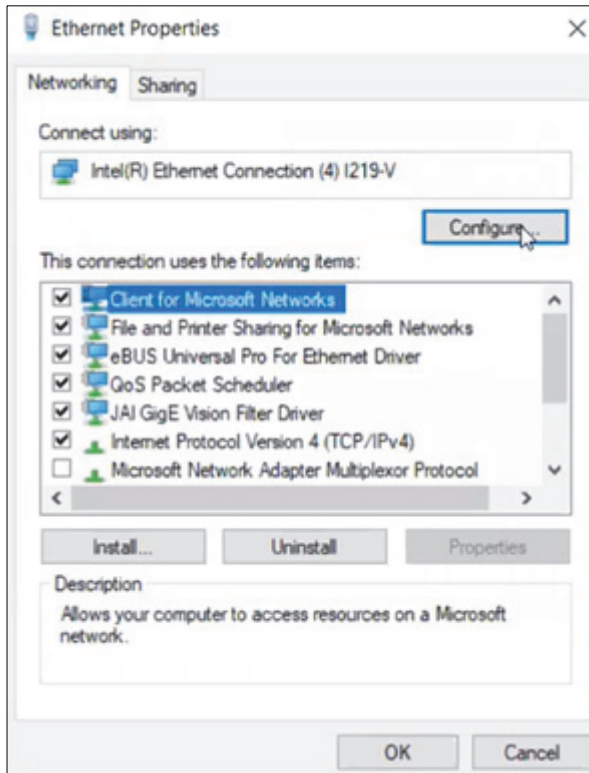

- 6** On the **Power Management** tab, verify that the **Allow the computer to turn off this device to save power** option is **not** selected.

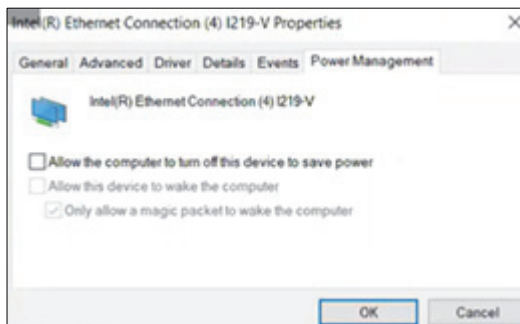

Warning: If this option is selected, when the computer goes into **Power Save Mode** it will also turn off the V275 Print Inspection Engine. Leave this device on at all times by leaving this option unchecked.

- 7** In the **Advanced** tab, select **Jumbo Packet**, select the largest available packet from the **Value** dropdown menu, and then click **OK**.

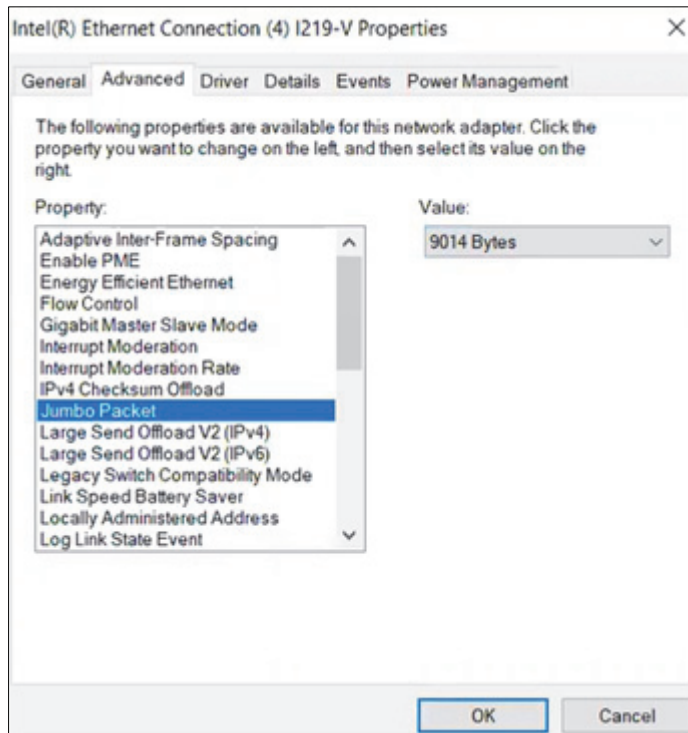

V275 Print Inspection Software uses jumbo packets for video transfer to the V275 Print Inspection Engine.

- 8** Select **Receive Buffers**, select the largest value available from the **Value** dropdown menu, and then click **OK**.

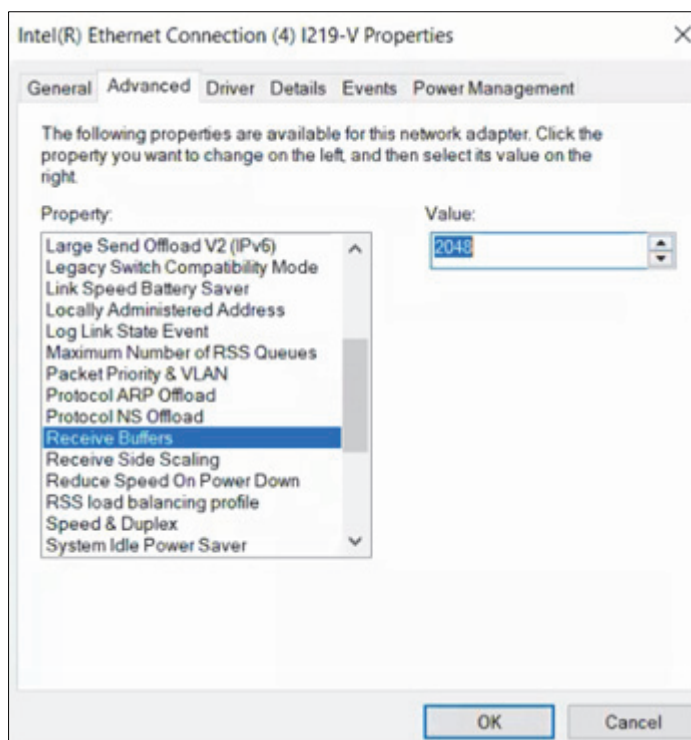

Increasing receive buffers allows the kernel more memory to buffer incoming packets and prevents potential dropped packets under high load and PC interruptions. For this reason, you want to select the maximum value.

- 9** Click **OK** to return to the **Ethernet Properties** dialog box.

3-2-1 Configuring IP Addresses for the V275 Server NICs

You will need to configure a static IP address *for each network card connected to a V275 Image Acquisition device*.

- 1 From the **Ethernet Properties** dialog, select **Internet Protocol Version 4 (TCP/IPv4)**, and then click **Properties**.

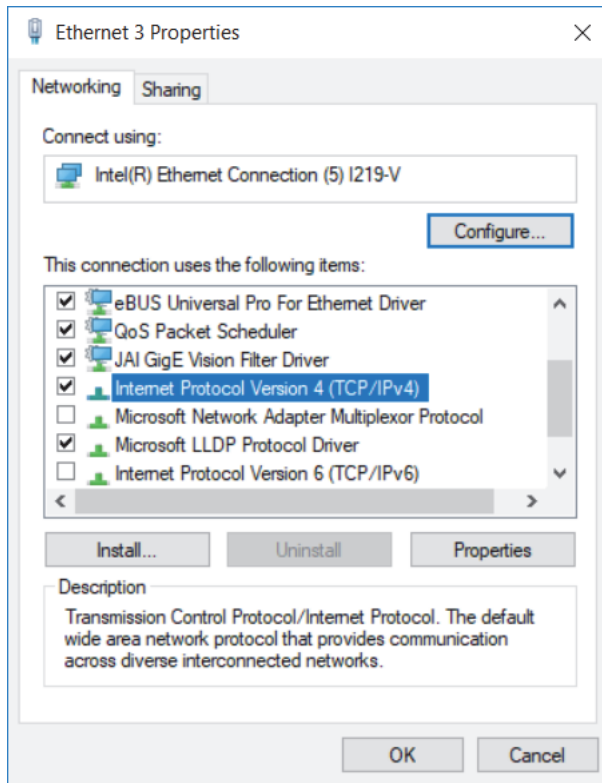

- 2 From the **Internet Protocol Version 4 (TCP/IPv4) Properties** dialog, select the **Use the following IP address** radio button. Enter the IP address to conform to the IP address structure for the network card you want to configure, and then click **OK**.

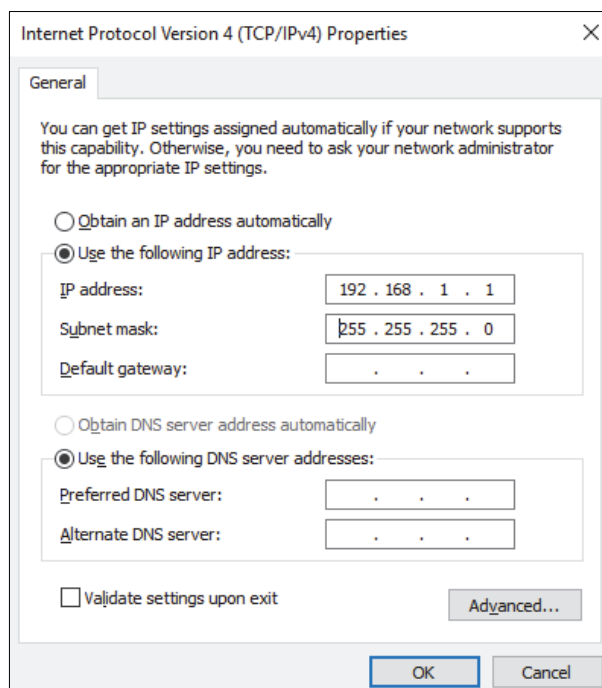

3-3 Configuring the V275 Imaging Device Network Interface

The V275 Image Acquisition Engine leverages Pleora GigE vision technology. Part of the installation includes Pleora's application utility called eBUSPlayer.

- 1 From the Windows Start button, select **Omron V275 > eBusPlayer** to open the application.

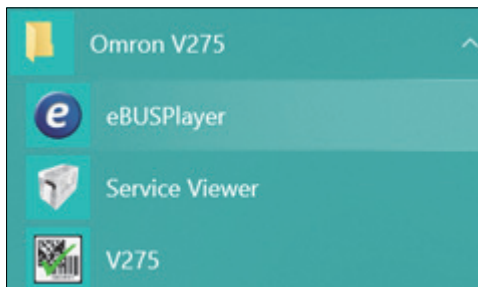

- 2 Follow the instructions below to connect to each device you want to configure.

3

3-3-1 Configuring a Static IP Address on the V275 Imaging Device

- 1 From **eBUS Player**, click **Select / Connect**.

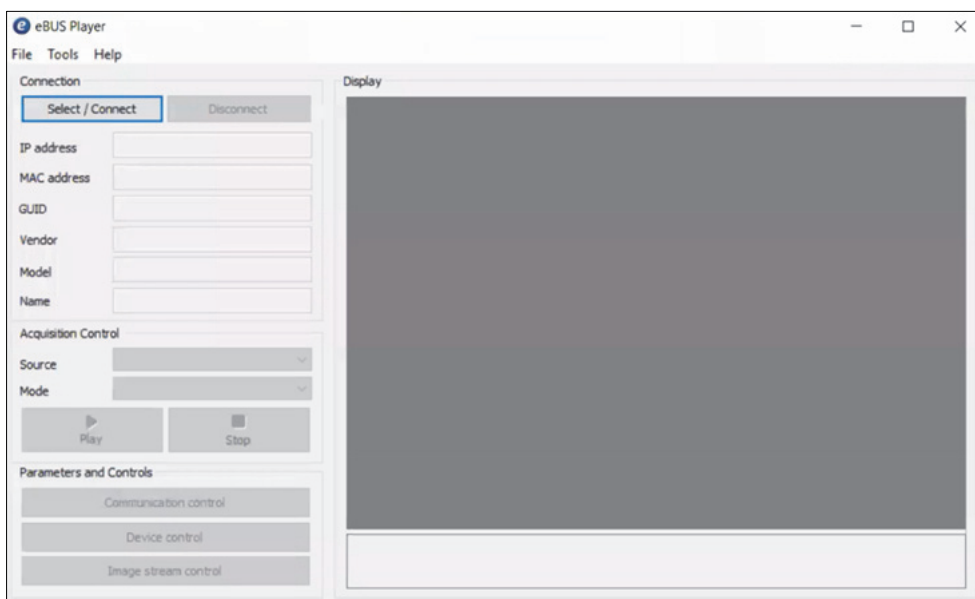

2 When setting up new devices, your device will not be visible.

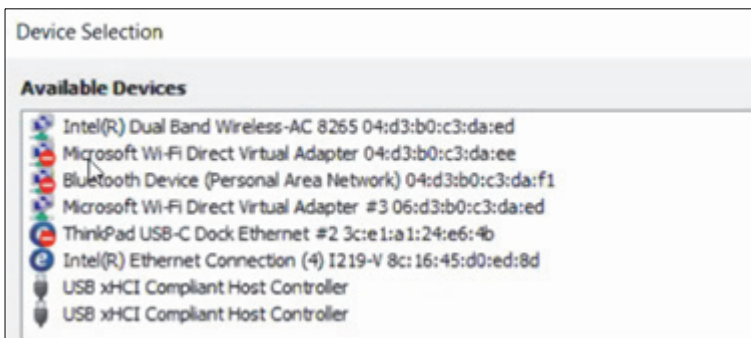

3 At the bottom of the page, select the **Show Unreachable Network Devices** checkbox, and then locate the network adapter connected to the target V275 Print Inspection Hardware unit.

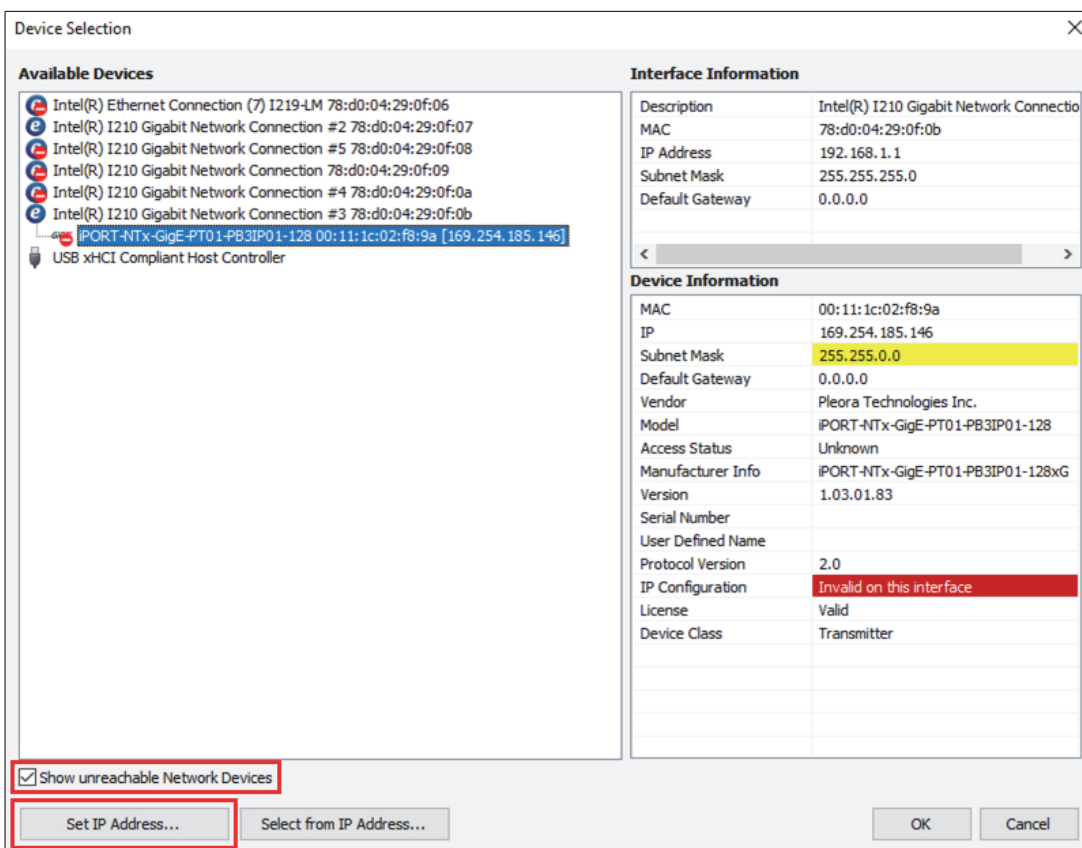

4 Select the device you want to connect to, and then click **Set IP Address**.

Note: The MAC address for your V275 Print Inspection Engine is located on a label inside the media compartment of the printer. The MAC address can be used to help you determine what device you need to connect to the correct octet.

Note: The eBUS player will automatically initialize the subnet and the first three octets of the IP Address.

5 From the **Set IP Address** dialog, set the fourth octet of the IP Address to the correct octet. In our example, we are using 2 for the V275 Print Inspection Engine.

6 Click **OK**.

Note: If you get a message stating that it cannot connect to the device, make sure that the device cables are properly connected to the printer and to the server.

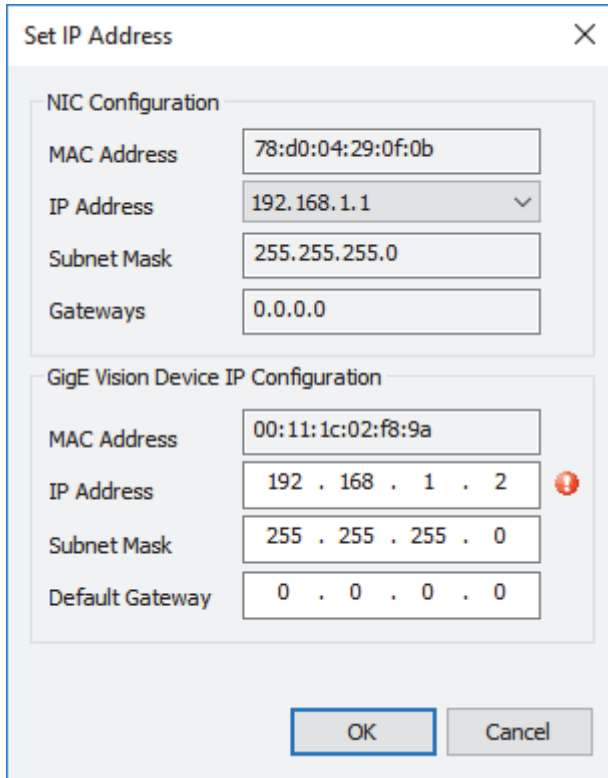

The image shows a 'Set IP Address' dialog box with two sections: 'NIC Configuration' and 'GigE Vision Device IP Configuration'. The 'NIC Configuration' section has fields for MAC Address (78:d0:04:29:0f:0b), IP Address (192.168.1.1), Subnet Mask (255.255.255.0), and Gateways (0.0.0.0). The 'GigE Vision Device IP Configuration' section has fields for MAC Address (00:11:1c:02:f8:9a), IP Address (192 . 168 . 1 . 2), Subnet Mask (255 . 255 . 255 . 0), and Default Gateway (0 . 0 . 0 . 0). A red warning icon is present next to the IP Address field in the GigE section. At the bottom are 'OK' and 'Cancel' buttons.

NIC Configuration	
MAC Address	78:d0:04:29:0f:0b
IP Address	192.168.1.1
Subnet Mask	255.255.255.0
Gateways	0.0.0.0

GigE Vision Device IP Configuration	
MAC Address	00:11:1c:02:f8:9a
IP Address	192 . 168 . 1 . 2
Subnet Mask	255 . 255 . 255 . 0
Default Gateway	0 . 0 . 0 . 0

3-3-2 Setting the V275 Imaging Device to a Persistent IP Address

If the V275 is powered down and then restarted, it will revert to default IP settings. The following steps will make the network settings persist across a restart. You must disable DHCP and instruct the V275 Print Inspection Engine to use the configured persistent IP. Configure the 4 device settings for the GigE transport layer as shown below.

- 1 From the **Device Selection** window, double-click on the device you want to manage.

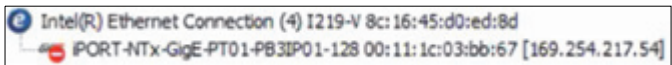

- 2 Once connected, click the **Device Control** button to open the Device Control dialog.

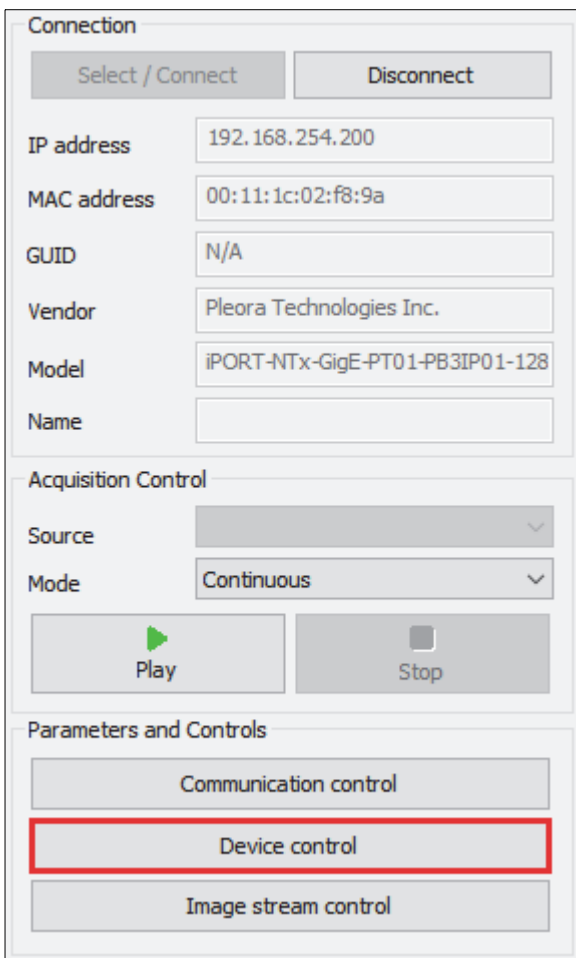

3 Navigate to the **TransportLayerControl** > **GigE Vision** settings.

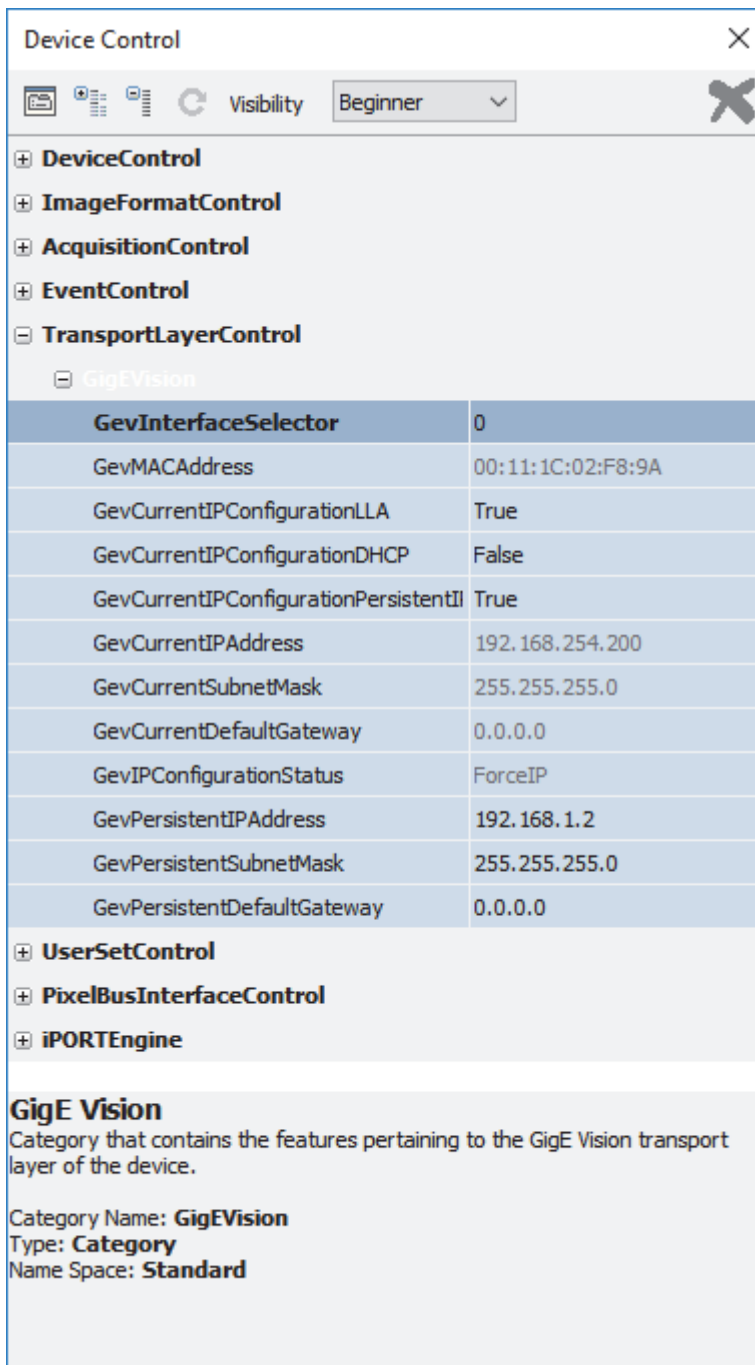

The screenshot shows the 'Device Control' window with a 'Beginner' visibility level. The 'TransportLayerControl' category is expanded to show the 'GigE Vision' sub-category. Below this, a table lists various network configuration parameters and their values.

GevInterfaceSelector	0
GevMACAddress	00:11:1C:02:F8:9A
GevCurrentIPConfigurationLLA	True
GevCurrentIPConfigurationDHCP	False
GevCurrentIPConfigurationPersistentII	True
GevCurrentIPAddress	192.168.254.200
GevCurrentSubnetMask	255.255.255.0
GevCurrentDefaultGateway	0.0.0.0
GevIPConfigurationStatus	ForceIP
GevPersistentIPAddress	192.168.1.2
GevPersistentSubnetMask	255.255.255.0
GevPersistentDefaultGateway	0.0.0.0

Below the table, the following categories are listed with expandable icons:

- UserSetControl**
- PixelBusInterfaceControl**
- iPORTEngine**

GigE Vision
 Category that contains the features pertaining to the GigE Vision transport layer of the device.
 Category Name: **GigE Vision**
 Type: **Category**
 Name Space: **Standard**

4 Disable DHCP and set the IP address to be permanent by changing the GigE transport layer settings.

- (1) **GevCurrentIPConfigurationDHCP => False**
- (2) **GevCurrentIPConfigurationPersistentIP => True**
- (3) **GevPersistentIPAddress => 192.168.1.2** (Intended as an example only.)
- (4) **GevPersistentSubnetMask => 255.255.255.0** (intended as an example only)

Device Control	
Visibility: Guru	
TransportLayerControl	
GigEVision	
GevPhysicalLinkConfiguration	SingleLink
GevCurrentPhysicalLinkConfiguration	SingleLink
GevSupportedOptionSelector	SingleLink
GevSupportedOption	True
GevInterfaceSelector	0
GevMACAddress	00:11:1C:02:F8:9A
GevPAUSEFrameReception	False
GevCurrentIPConfigurationUA	True
GevCurrentIPConfigurationDHCP	False
GevCurrentIPConfigurationPersistentIP	True
GevCurrentIPAddress	192.168.1.2
GevCurrentSubnetMask	255.255.255.0
GevCurrentDefaultGateway	0.0.0.0
GevIPConfigurationStatus	ForceIP
GevPersistentIPAddress	192.168.1.2
GevPersistentSubnetMask	255.255.255.0
GevPersistentDefaultGateway	0.0.0.0
GevTimestampTickFrequency	66666666
GevIEEE1588	False

5 Click the X at the top of the **Device Control** dialog box to end the session.

Device Control	
Visibility: Guru	
EventSelector	PlcEventQueue0
EventNotification	Off
TransportLayerControl	
GigEVision	
GevPhysicalLinkConfiguration	SingleLink
GevCurrentPhysicalLinkConfigurator	SingleLink

- 6** Click the **X** at the top-right corner of the **eBUS Player** to exit from the software.



- 7** Click **OK** when the message appears indicating that the session configuration has changed.

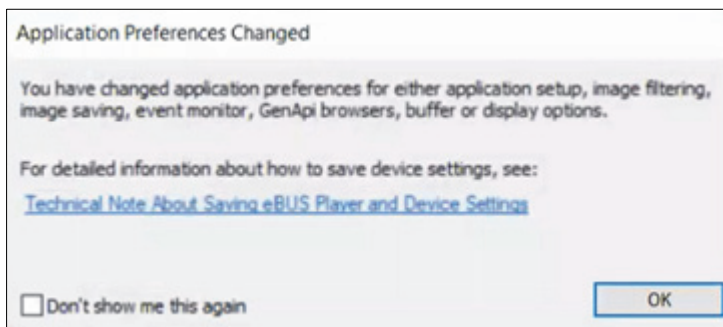

- 8** Close the eBUS Player software as it cannot be running at the same time as the V275 Software.

4

Hardware Configuration

This section describes ZT6x0 printer settings, and shows how to load print media in multiple configurations.

4

4-1	Configuring V275 Printer Hardware	4-2
4-1-1	ZT6x0 Printer Configuration	4-2
4-1-2	General Settings	4-2
4-1-3	Applicator Settings	4-2
4-1-4	Energy Star Settings	4-3
4-2	Loading Media for V275 Hardware	4-4
4-2-1	Media Loading When Front-Ejecting or Tearing Off Labels	4-4
4-2-2	Media Loading When Peeling Labels	4-7
4-2-3	Media Loading When Rewinding Labels	4-12
4-2-4	Loading the Ribbon	4-16

4-1 Configuring V275 Printer Hardware

4-1-1 ZT6x0 Printer Configuration

In general, using these configuration settings on the Zebra printers will provide optimal operation of the V275 system.

1 PRINT MODE = TEAR OFF

- This is the default mode and is used so that the printer operator can tear off the printed labels at any time after they print. Other configurations such as REWIND or APPLICATOR are not supported and should not be used.

2 TEAR OFF = nnn

- This value controls the movement of the media out of the printer over the tear-off bar by the specified number of dots. The value must be large enough to eject the top of label at least 0.08" past the active scan read line when the label is complete. This value should be 60 for a 300 DPI printer and 120 for a 600 DPI printer. Setting this value to the maximum (120) should work just fine.
 - Negative numbers move the media into the printer by the specified number of dots (the tear line moves closer to the edge of the label just printed).
 - Positive numbers move the media out of the printer (the tear line moves closer to the leading edge of the next label).

Note: Accepted values range from 120 to 120.

3 APPLICATOR PORT = MODE 1

- This setting will ensure expected I/O polarity and functionality

4 START PRINT SIG = LEVEL MODE

- Ensures expected stop / start motion control

5 ENERGY STAR = OFF

- When Energy Star mode is enabled, the printer goes into a "sleep" mode after a timeout period, thereby lowering power consumption. Press any button on the control panel to bring the printer back to an active state.

Warning: You must disable Energy Star through the front panel instead of through the Printer configuration software.

4-1-2 General Settings

All printer settings required for optimal V275 functionality have been preset at the factory. In the case of a printer reset, however, the following Applicator settings are required for correct operation of your device.

4-1-3 Applicator Settings

If you need to enable the peel and present operation, the applicator port will need to be reconfigured as described below.

Setting	Value
Applicator	Mode 1
Start Print Sig	LEVEL MODE for Labels \geq 2" Tall
	PULSE MODE for Labels $<$ 2" Tall

To Access the Applicator Settings via the Printer Web Server Interface:

- 1** Connect the printer to your local network via an Ethernet cable, and follow the instructions below:
 - (1) Use a web browser to navigate to the IP address displayed on the printer's user interface.
 - (2) On the printer landing page, navigate to **View and Modify Printer Settings > Advanced Setup**.
 - (3) When prompted for a password, enter **1234**.
 - (4) Set the desired parameters and click **Submit Changes** to save changes temporarily.
(Cycling power will restore previous settings.)
- 2** To permanently save the settings, click **Save Current Configuration** on the subsequent page.

4-1-4 Energy Star Settings

To prevent the printer from entering sleep mode during the print process and causing it to be unresponsive to the V275's commands, turn OFF **Energy Star** under the Tools menu in the printer interface.

The subsequent sections cover settings and label routing pertaining to specific printer/verifier configurations.

4-2 Loading Media for V275 Hardware

4-2-1 Media Loading When Front-Ejecting or Tearing Off Labels

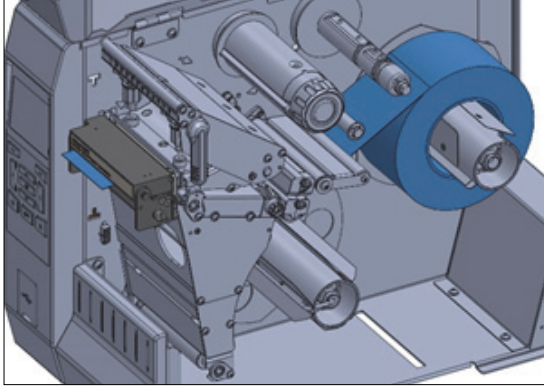

Caution

The printhead may be hot and could cause severe burns. Allow the printhead to cool before touching.

- 1** If necessary, install the rewind bar in the peel-off position as shown.

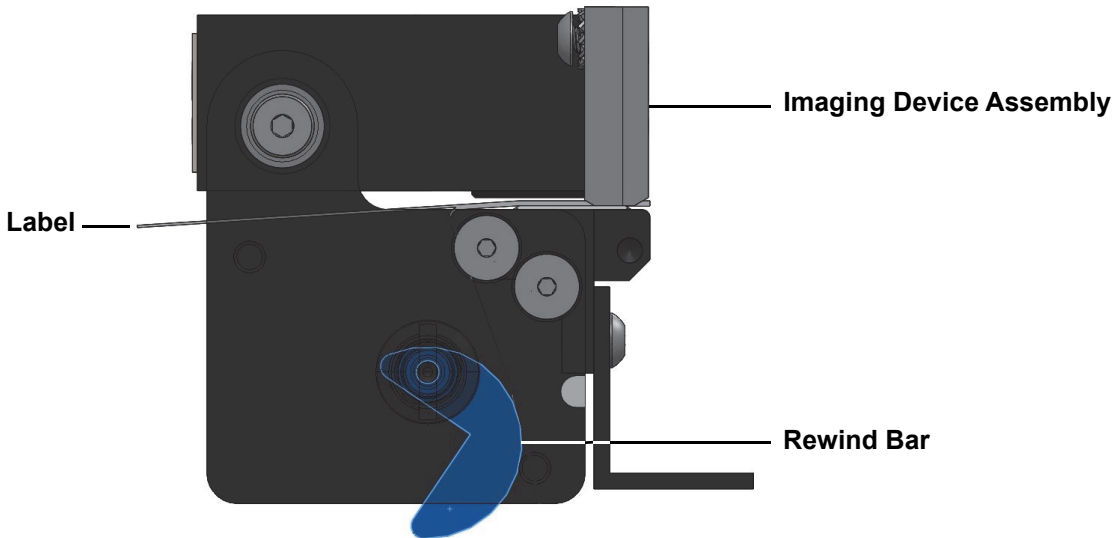

- 2** Open the imaging device assembly by rotating the imaging device upward.
- 3** Open the printhead assembly by rotating the printhead-open lever upward.

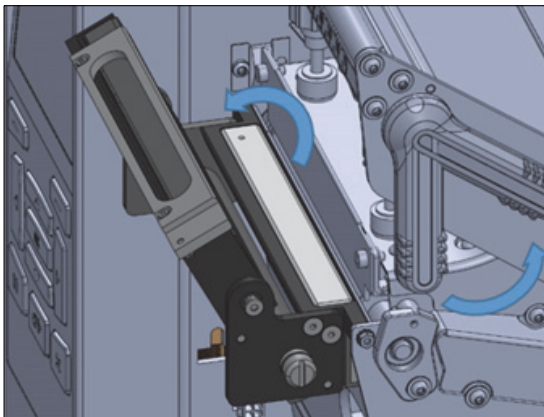

- 4** Rotate the media guide adjustment knob as shown until the media guide slides all the way out.

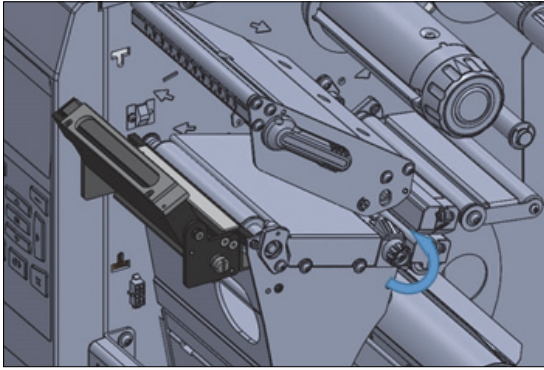

Caution

The printhead may be hot and could cause severe burns. Allow the printhead to cool before touching.

- 5** Feed the media by following the instructions below.

- From the media spindle (1):
 - Feed the media under the dancer assembly (2);
 - Through the media sensor (3);
 - Under the printhead assembly (4);
 - Through the imaging device assembly (5);
 - Slide the media back until it touches the inside back wall of the media sensor (6).

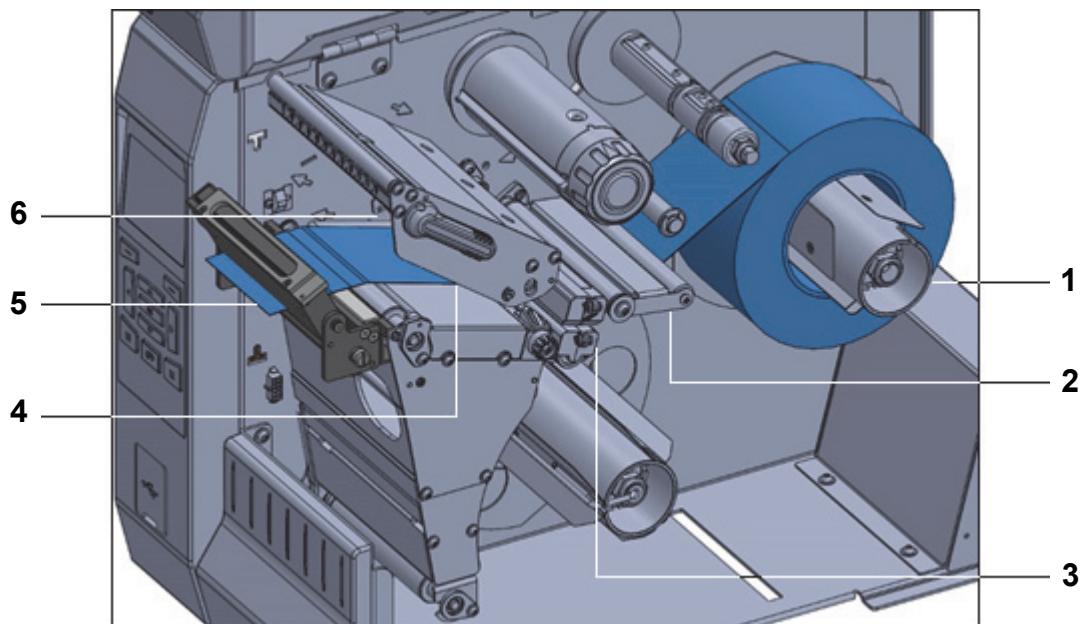

- 6** Rotate the media guide adjustment knob as shown until the media guide just touches the edge of the media.

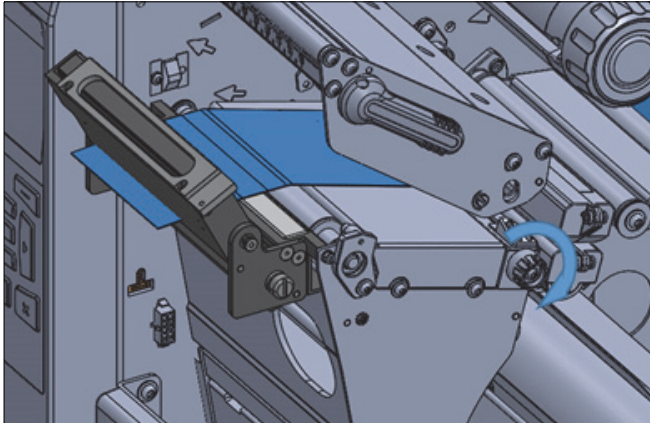

Does the media require a ribbon for printing?

If Using...	Then...
Direct thermal media (no ribbon needed)	Continue with step 6.
Thermal transfer media (ribbon needed)	If you have not already done so, load ribbon in printer. Continue with step 6.

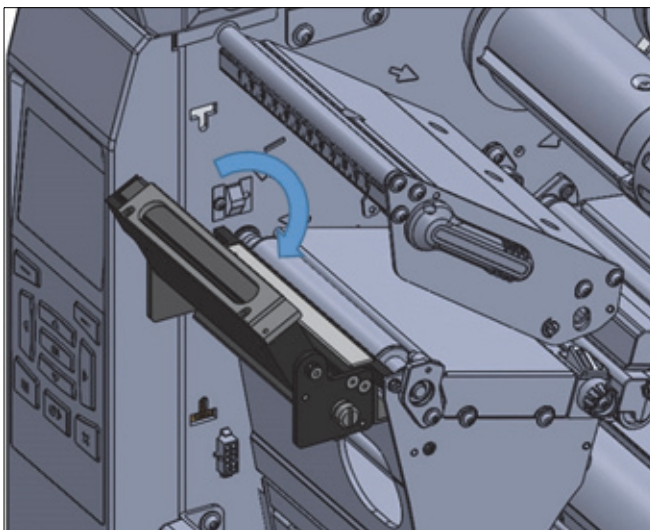
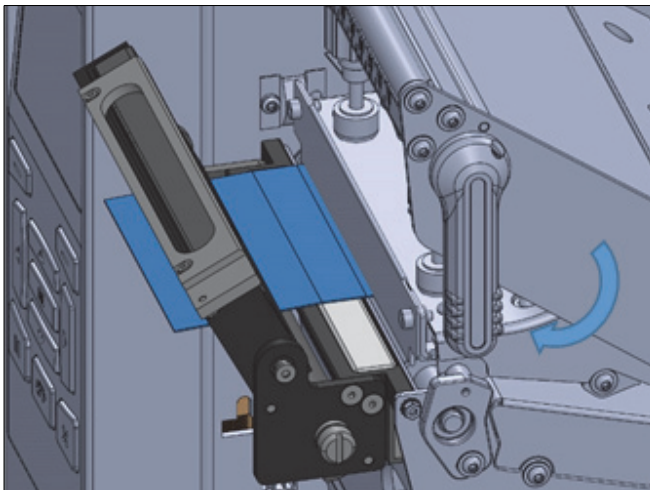

- 7** Rotate the printhead-open lever downward until it locks the printhead in place.

- 8** Close the imaging device.
- 9** Close the media door and press **PAUSE** to exit Pause mode, and to enable printing.
Note: The printer may automatically want to perform a label calibration or feed a label, depending on your settings.
- 10** For best results, calibrate the printer.
- 11** If desired, print a configuration or other label to verify that your printer is able to print.
Media loading for front-eject or tear-off configuration is complete.

4-2-2 Media Loading When Peeling Labels

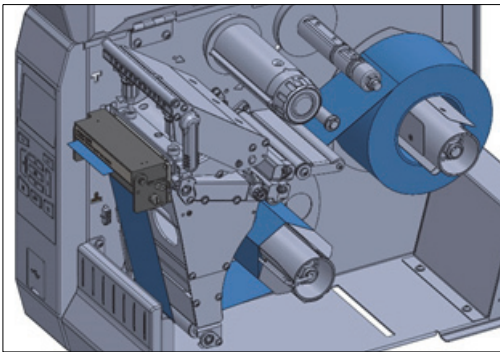

- 1** If necessary, install the rewind bar in the peel-off position as shown.

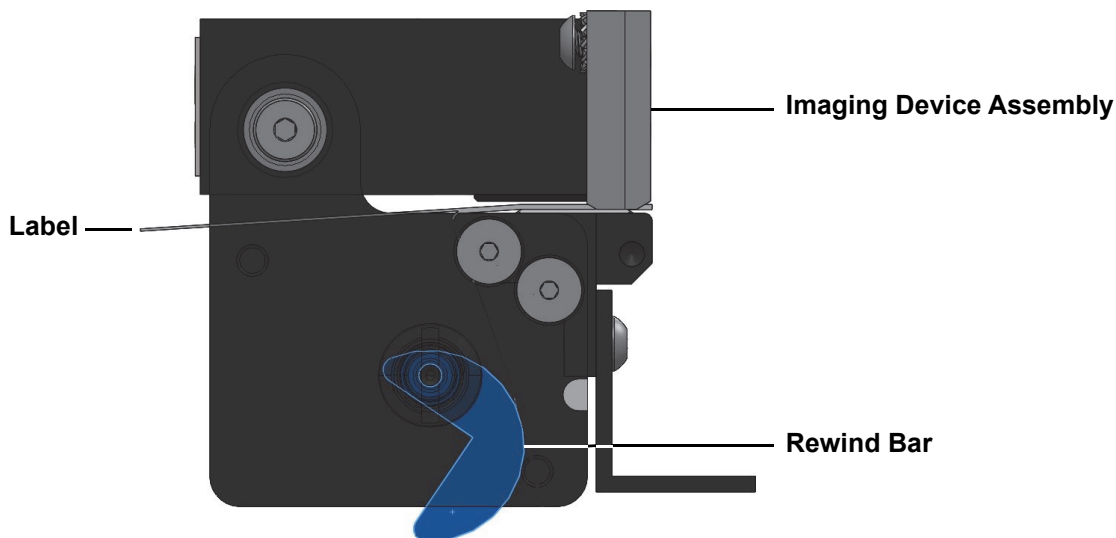

- 2** If desired, slide a core onto the rewind spindle until it is flush against the guide plate. A core is not necessary for liner take-up.

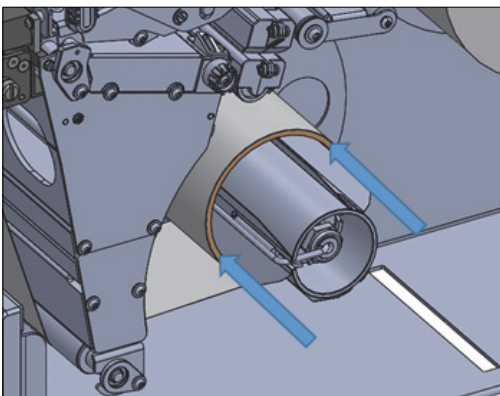

- 3** Open the imaging device assembly by rotating the imaging device upward.



Caution

The printhead may be hot and could cause severe burns. Allow the printhead to cool before touching.

- 4** Open the printhead assembly by rotating the printhead-open lever upward.

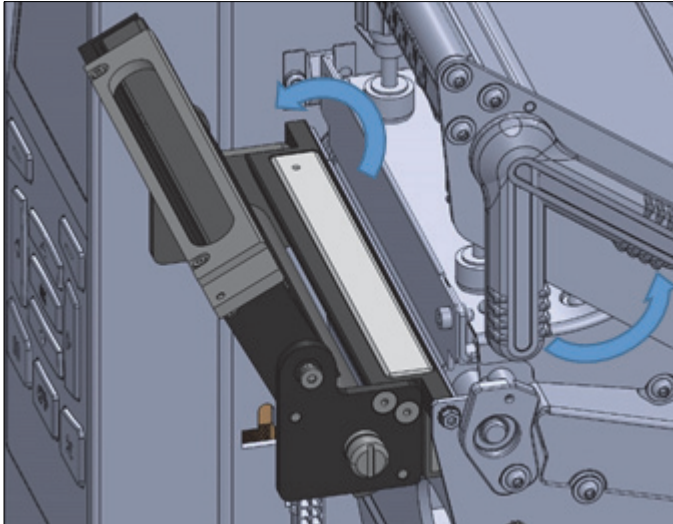

- 5** Rotate the media guide adjustment knob as shown until the media guide slides all the way out.

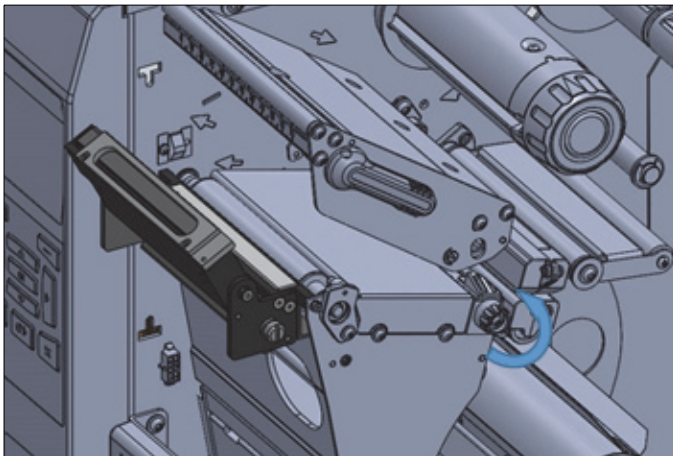

Caution

The printhead may be hot and could cause severe burns. Allow the printhead to cool before touching.

- 6** Feed the media by following the instructions below.
- From the media spindle (1):
 - Feed the media under the dancer assembly (2);
 - Through the media sensor (3);
 - Under the printhead assembly (4);
 - Through the imaging device assembly (5);
 - Slide the media back until it touches the inside back wall of the media sensor (6).

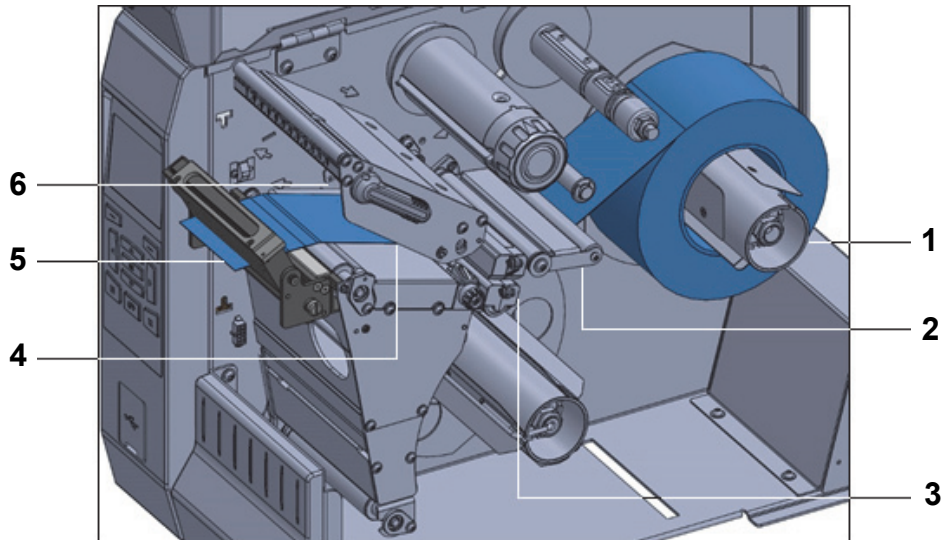

- 7** Extend approximately 18 in. (500 mm) of media out of the printer.
- 8** Remove and discard the labels from this exposed media, leaving just the liner.
- 9** Feed the liner behind the rewinder bar.

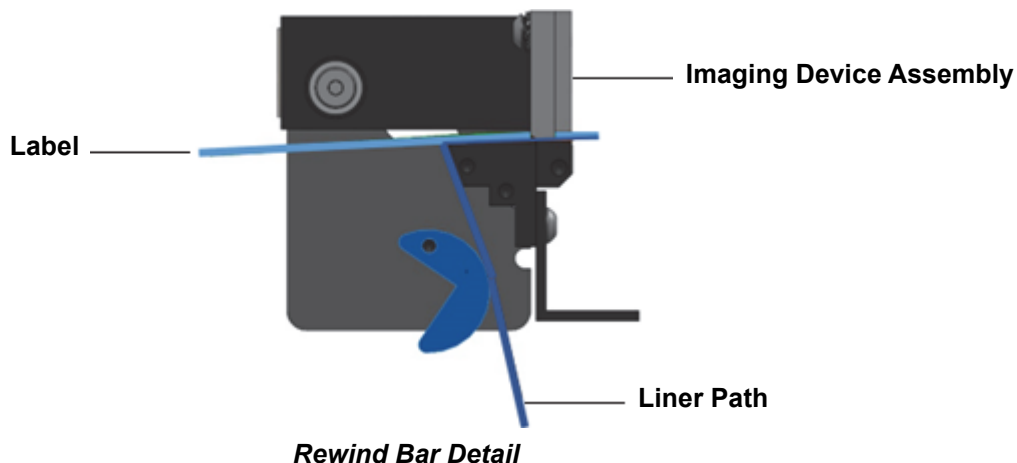
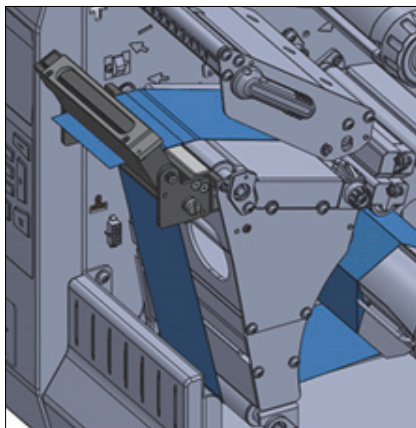

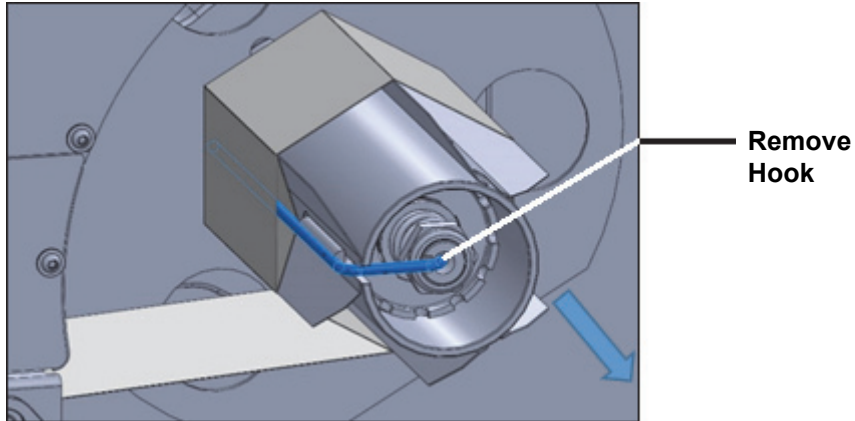

- 10** If not using a core on the rewind spindle:
- Remove the hook from the rewind spindle.
 - Wind the liner around the rewind spindle as shown.
 - Rotate the rewind spindle several turns to tighten the liner and remove any slack.
 - Reinstall the spindle hook over the liner.
 - Insert the long end of the hook into the small hole on the guide plate.
 - Insert the short end of the hook into the hole in the center of the adjusting nut.
 - Rotate the media knob.

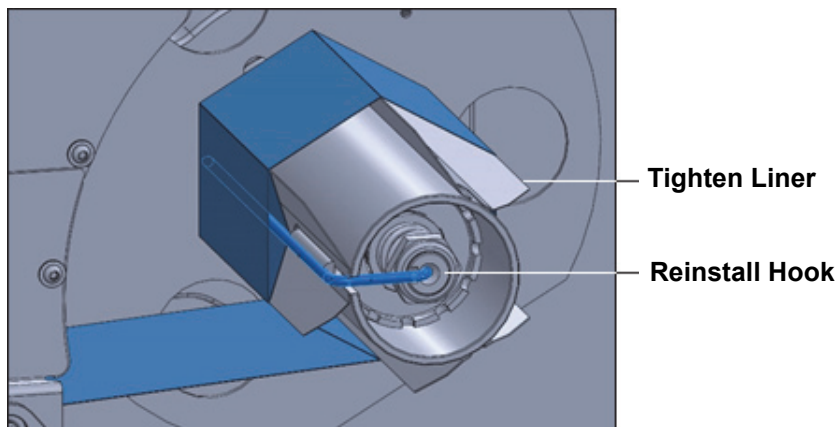

- 11** Rotate the media guide adjustment knob as shown until the media guide just touches the edge of the media.

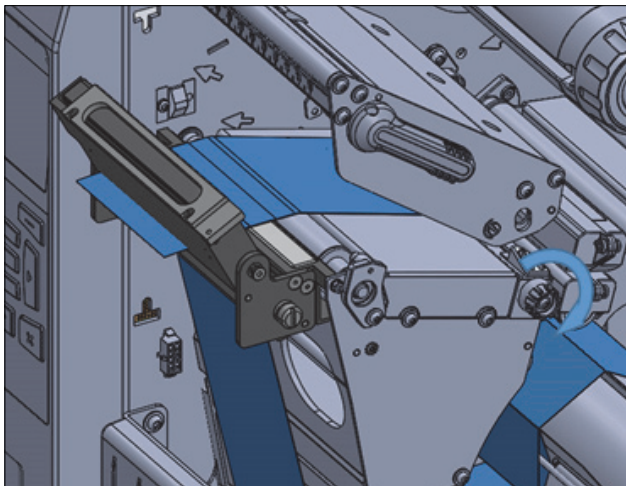

Does your media require a ribbon for printing?

If Using...	Then...
Direct thermal media (no ribbon needed)	Continue with step 12.
Thermal transfer media (ribbon needed)	If you have not already done so, load ribbon in printer.
	Continue with step 12.

12 Rotate the printhead-open lever downward until it locks the printhead in place.

13 Close the imaging device.

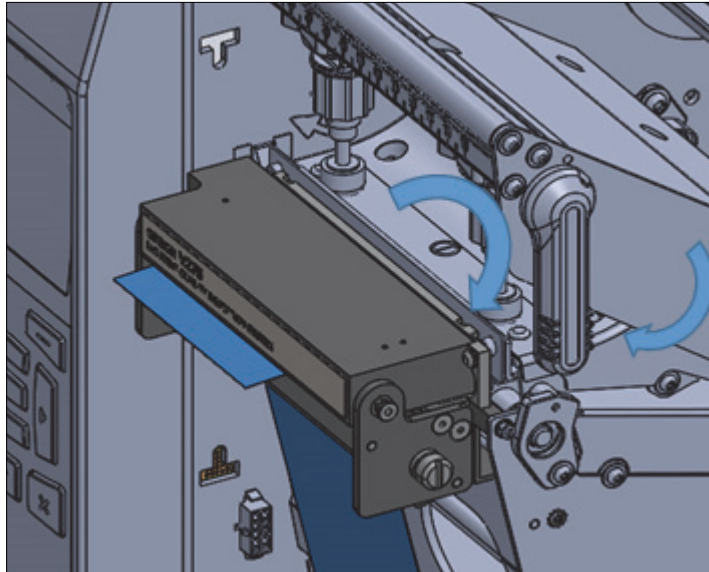

14 Close the media door, press **PAUSE** to exit Pause mode and to then enable printing.

Note: The printer may perform a label calibration or feed a label, depending on your settings.

15 For best results, calibrate the printer.

16 If desired, print a configuration or other label to verify that your printer is able to print.

Media loading for peel-off configuration is complete.

4-2-3 Media Loading When Rewinding Labels

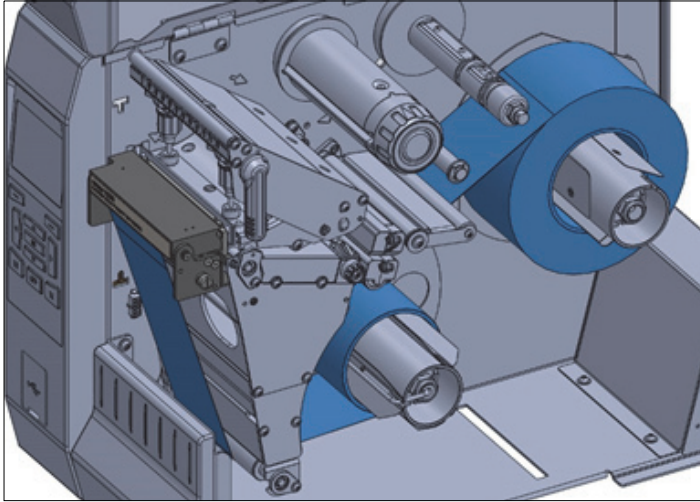

- 1** If necessary, install the rewind bar in the rewind position as shown.



- 2** Slide a core onto the rewind spindle until it is flush against the guide plate.

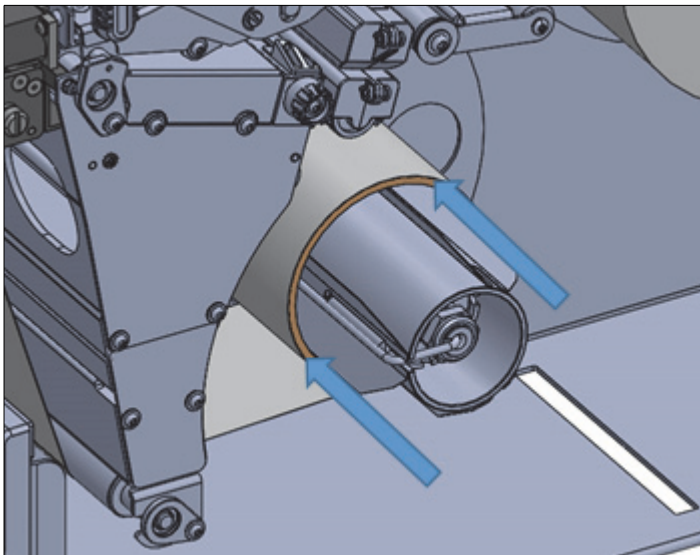

Caution

The printhead may be hot and could cause severe burns. Allow the printhead to cool before touching.

- 3** Open the imaging device assembly by rotating the imaging device upward.

- 4** Open the printhead assembly by rotating the printhead-open lever upward.

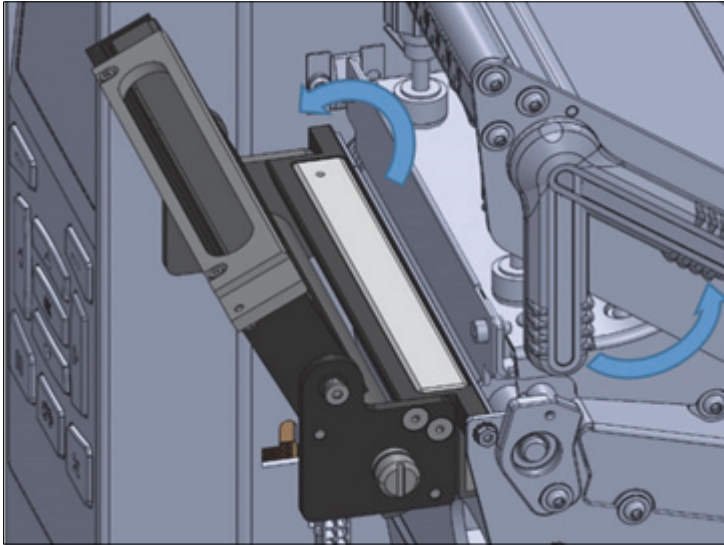

- 5** Rotate the media guide adjustment knob as shown until the media guide slides all the way out.

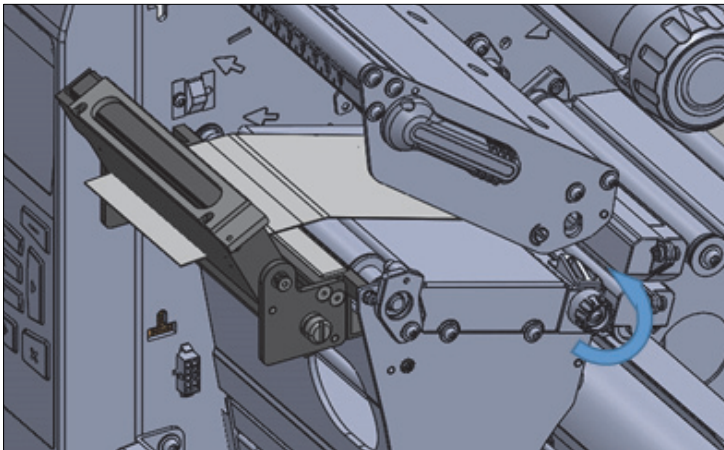

Caution

The printhead may be hot and could cause severe burns. Allow the printhead to cool before touching.

6 Feed the media by following the instructions below.

- From the media spindle (1):
 - Feed the media under the dancer assembly (2);
 - Through the media sensor (3);
 - Under the printhead assembly (4);
 - Through the imaging device assembly (5);
 - Slide the media back until it touches the inside back wall of the media sensor (6).

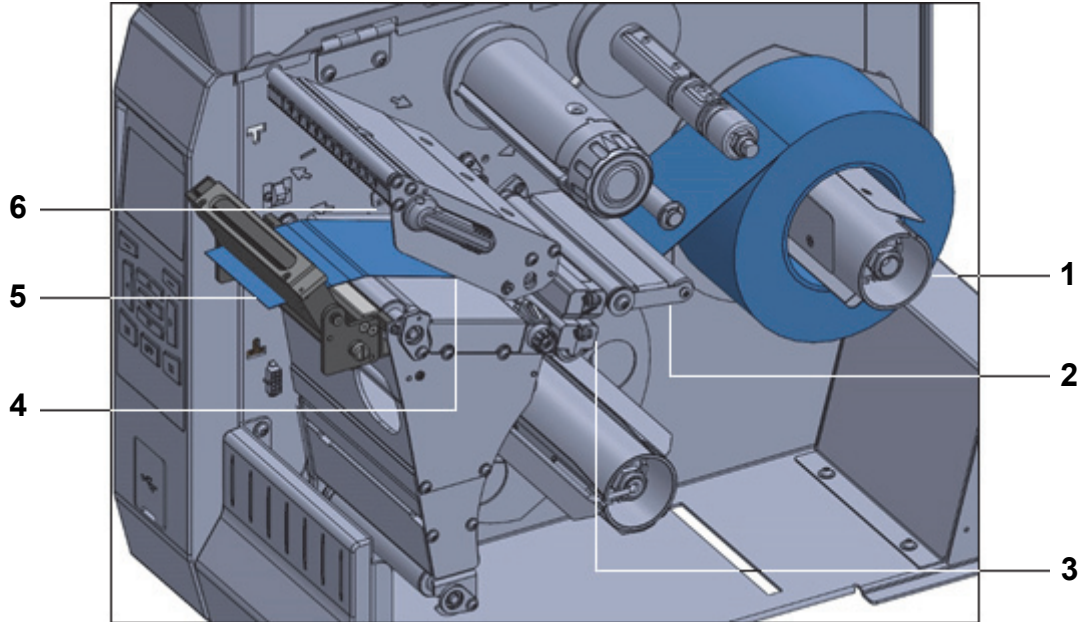

7 Extend approximately 18 in. (500 mm) of media out of the printer.

8 Feed the media over the rewind bar.

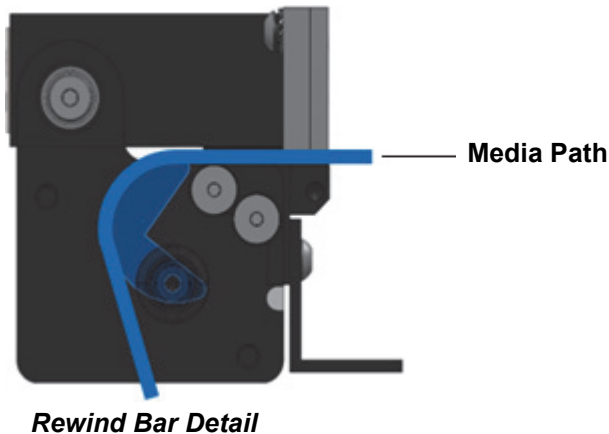
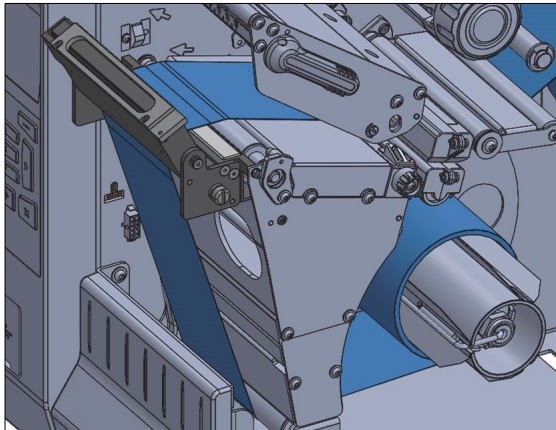

- 9** Wind the media around the rewind spindle as shown. Rotate the rewind spindle several turns to tighten the media and remove any slack.

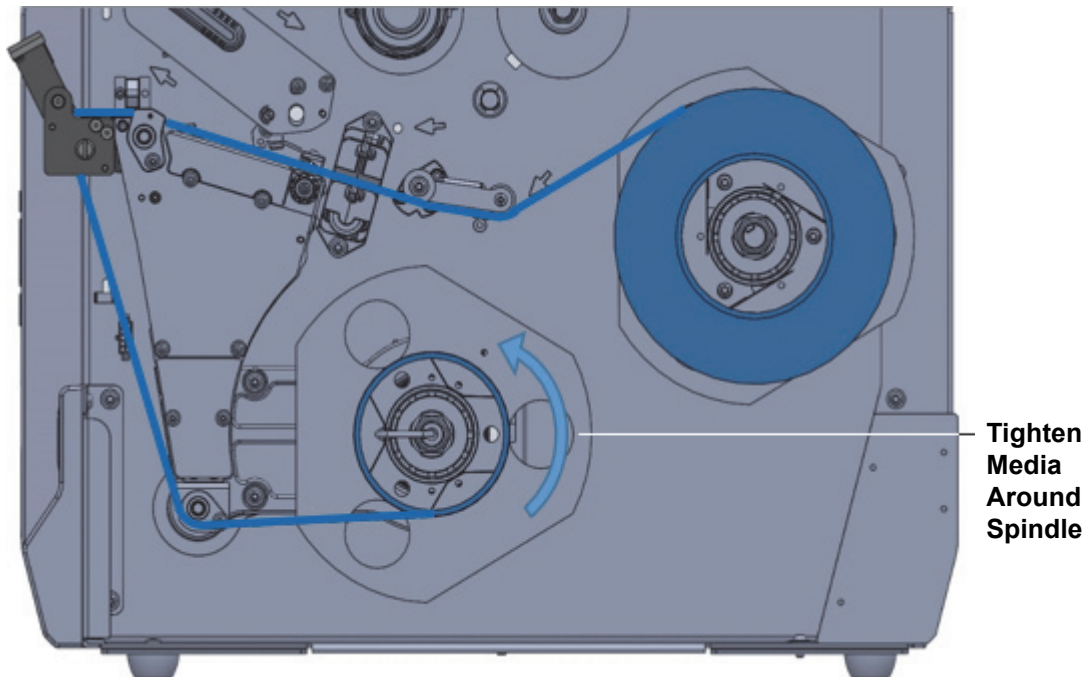

- 10** Rotate the media guide adjustment knob as shown until the media guide just touches the edge of the media.

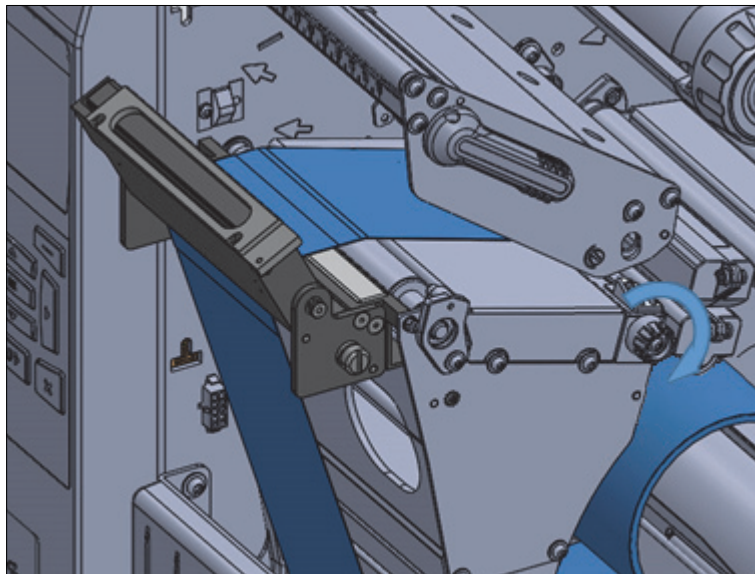

Does the media require a ribbon for printing?

If Using...	Then...
Direct thermal media (no ribbon needed)	Continue with step 11.
Thermal transfer media (ribbon needed)	If you have not already done so, load ribbon in printer.
	Continue with step 11.

- 11** Rotate the printhead-open lever downward until it locks the printhead in place.
- 12** Rotate the imaging device down until it rests on the label stock.
- 13** Close the printhead.

- 14** Close the imaging device.

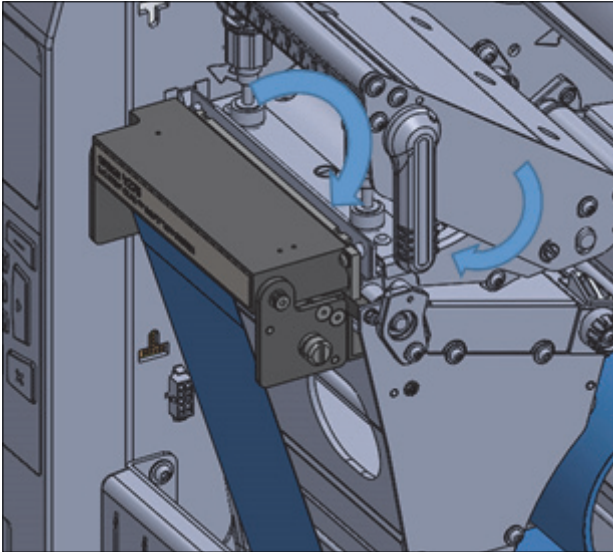

- 15** Close the media door, press **PAUSE** to exit Pause mode and to then enable printing.
Note: The printer may perform a label calibration or feed a label, depending on your settings.

- 16** For best results, calibrate the printer. See the printer user guide for instructions on how to calibrate the printer.

- 17** If desired, print a configuration or other label to verify that your printer is able to print.

Media loading for rewind configuration is complete.

4-2-4 Loading the Ribbon

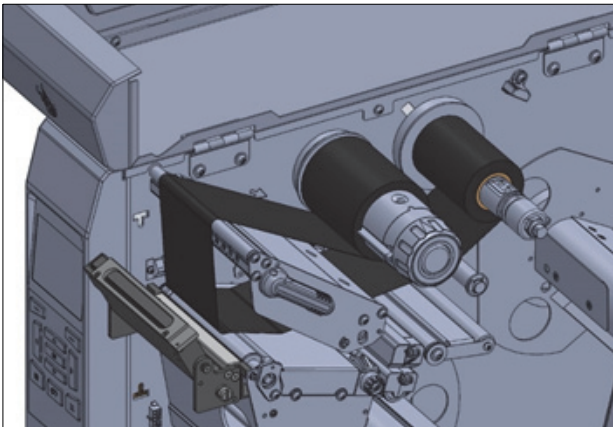

Caution

The printhead may be hot and could cause severe burns. Allow the printhead to cool before touching.

Note: These instructions assume **Ink Side Out** ribbon is used. **Ink Side In** ribbon applications are currently not supported.

- 1** Open the imaging device assembly by rotating the imaging device upward.
- 2** Open the printhead assembly by rotating the printhead-open lever upward.

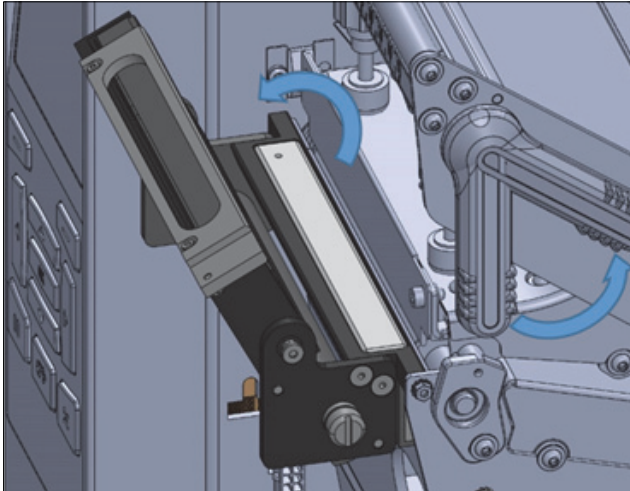

- 3** Slide the roll of ribbon onto the ribbon supply spindle with the loose end of the ribbon hanging down from the right side of the roll.
- 4** Push the ribbon roll onto the spindle as far as it will go.

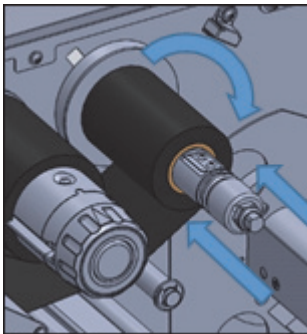

- 5** Run the loose end of the ribbon under the printhead and loop around the front end of the printhead. Do NOT pass the ribbon through the imaging device.
- 6** Run the ribbon as close as possible to the interior printer wall.
- 7** Run the ribbon under the ribbon take-up spindle and wrap around the top of the take-up spindle.
- 8** Rotate the take-up spindle several times in the direction indicated to tighten and align the ribbon.

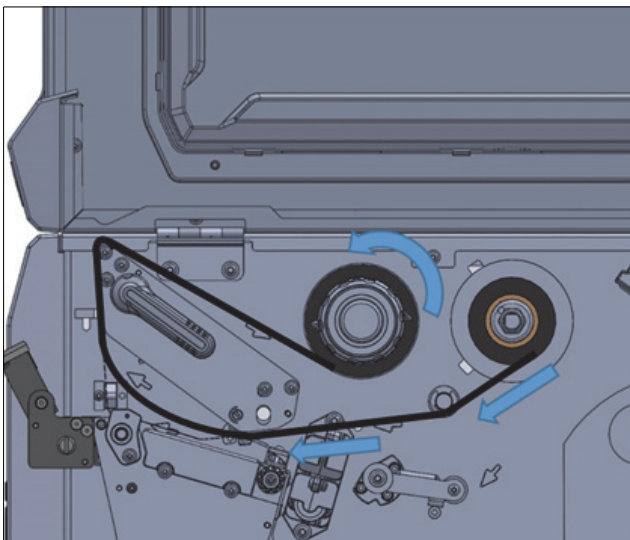

5

Software Installation

This section summarizes and describes how to install V275 Software.

5-1 V275 Software Overview	5-2
5-2 Operating System Requirements	5-2
5-3 Prerequisites	5-2
5-4 Installing V275 Software	5-3

5-1 V275 Software Overview

V275 Software consists of:

- Two core Windows applications;
- Two utility applications;
- A browser-based user interface.

The core applications for print inspection functionality are the service application **V275Service.exe**, and the main inspection application **V275.exe**. These are system applications that are automatically launched when the server PC is started. These applications enable the print inspection functionality to be available without user logon or initiation. Once the server is running, the UI is accessible through supported browsers launched on either the server itself (local) or on remote PCs within the same network (bandwidth and firewall permitting).

The two utility applications, **Service Viewer** and **eBUS Player**, are also installed and available to users logged into the server. The Service Viewer is launched automatically and is available through the task tray icon or Windows Start menu. This utility provides visual confirmation of the V275 application status and basic troubleshooting. The eBUS Player utility is accessible through the Start menu and can be used for device network setup and troubleshooting.

The browser-based user interface is described in [Section 6 – V275 User Interface](#).

5-2 Operating System Requirements

V275 Software is designed to run on 64-bit Windows only. All standard Windows 7 SP1 or newer versions are supported. Windows server versions 2008 R2 SP1 or newer are supported.

The instructions in this documentation are for Windows 10 64-bit . If you install your system on Windows 7, the screenshots and other instructions may vary slightly.

5-3 Prerequisites

Firewall Configuration Management for Remote Access

Firewall configuration management may be needed for remote access clients. To use a user interface that remotely accesses the server, the Server must allow bidirectional access to TCP ports 8080-8084.

Versioning

The installation is dependent on Pleora eBUS Player Version 5.1, GigE runtime. If your V275 Server has a different version of the eBUS Player installed on it, the installer will:

- Detect it;
- Notify you of its presence;
- Exit the installation process.

5-4 Installing V275 Software

- 1 Insert the USB flash drive into a port on the V275 Server.
- 2 Double-click on the latest version of the software (**v275.1.x.x.exe**) to begin the software installation process.

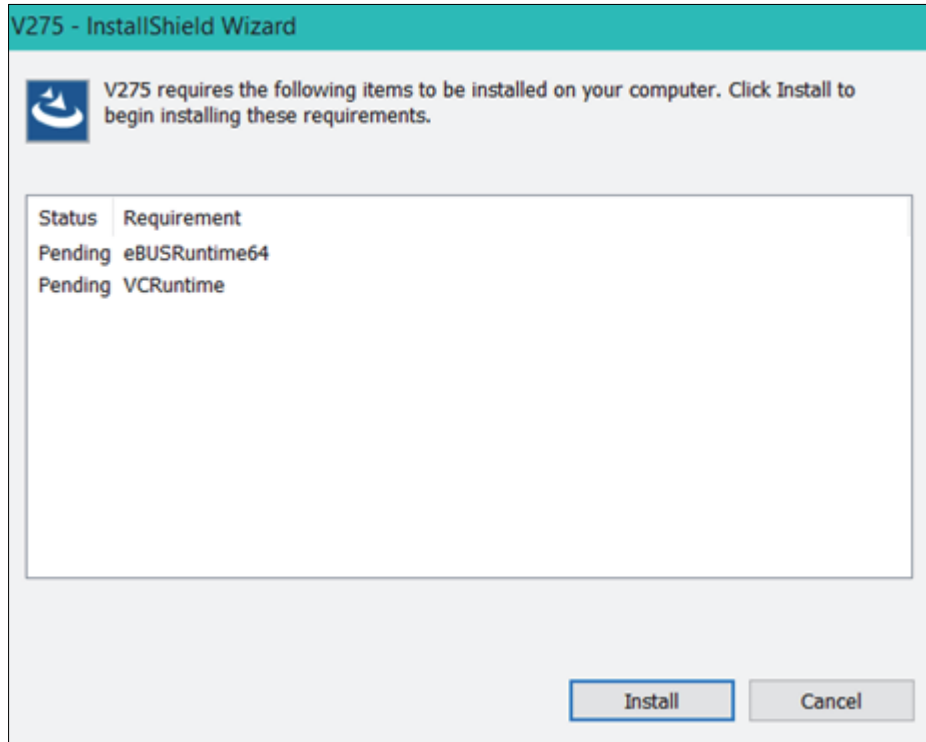

- 3 Click **Install**.

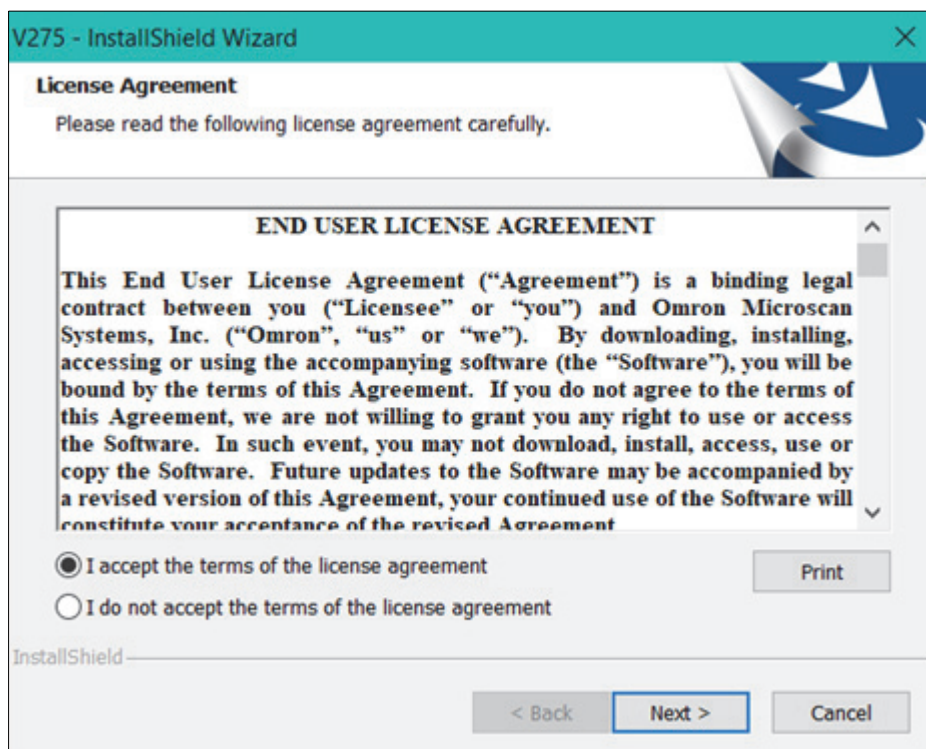

- 4 Click the **I accept the terms of the license agreement** radio button, and then click **Next**.
- 5 Click **Next** to continue the installation process.

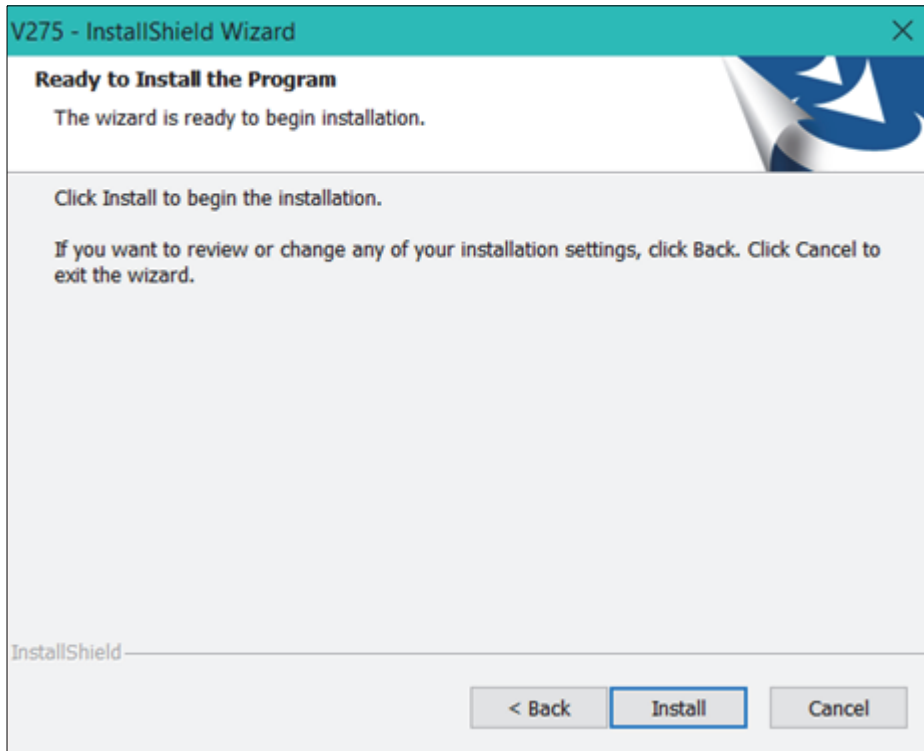

- 6 Click **Install**.

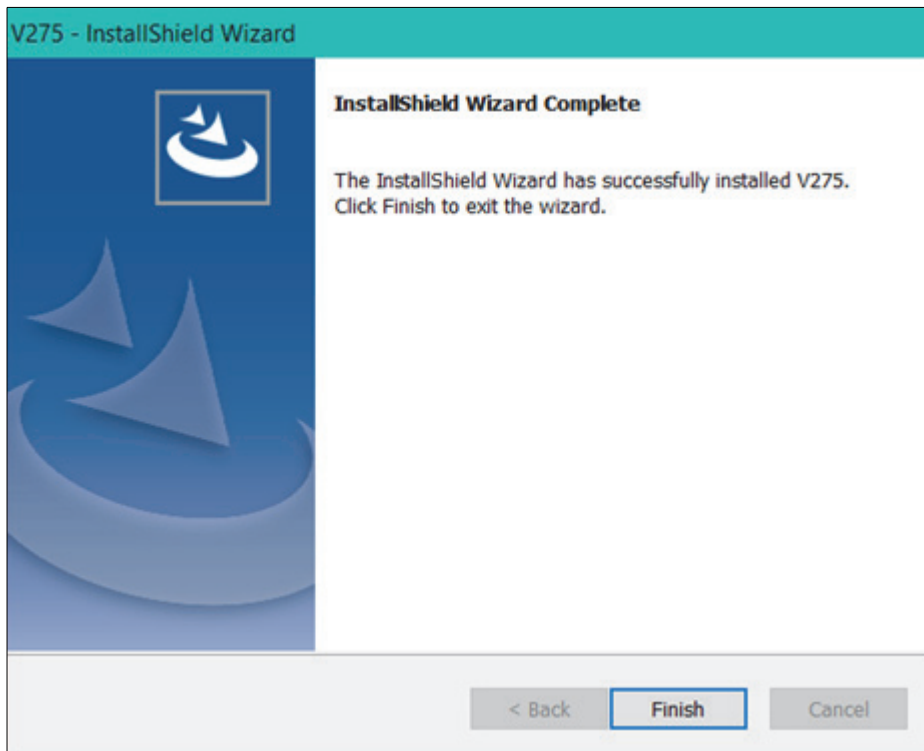

- 7 Click **Finish** to complete the installation.

A shortcut is added to the desktop on the V275 Server.



Note: V275 application files are installed in the **c:\Program Files\V275** folder. The eBUS Player executable is installed in **c:\Program Files\V275\install\utilities\lebus**.

A new folder and three application shortcuts will be added to the Start menu, as shown below:

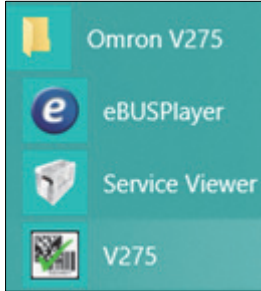

6

V275 User Interface

This section describes V275 Software's user interface.

6-1	V275 User Interface Overview	6-2
6-1-1	Main View and Navigation	6-2
6-1-2	Attached Devices	6-3
6-1-3	Attached Devices Panel	6-3
6-1-4	Using a Simulation Device	6-4
6-1-5	Advanced Session Configuration	6-5
6-1-6	Device Status and Template Management	6-5

6-1 V275 User Interface Overview

The V275 user interface is a web UI that can run in a supported browser either on the V275 server PC or a networked remote PC. This web application communicates to the V275 web server through ports 8080-8084. To launch the application, you need to provide an appropriate URL in a supported browser. This URL on the server PC is <http://127.0.0.1:8080/> and is provided as a shortcut during installation in the Omron start menu folder and desktop. To access from a remote PC you must provide the server IP address or properly resolved server name in place of 127.0.0.1 and have ports 8080-8084 accessible through the firewall if present.

6-1-1 Main View and Navigation

Launched for the first time with no devices connected the web UI will bring up the following application view.

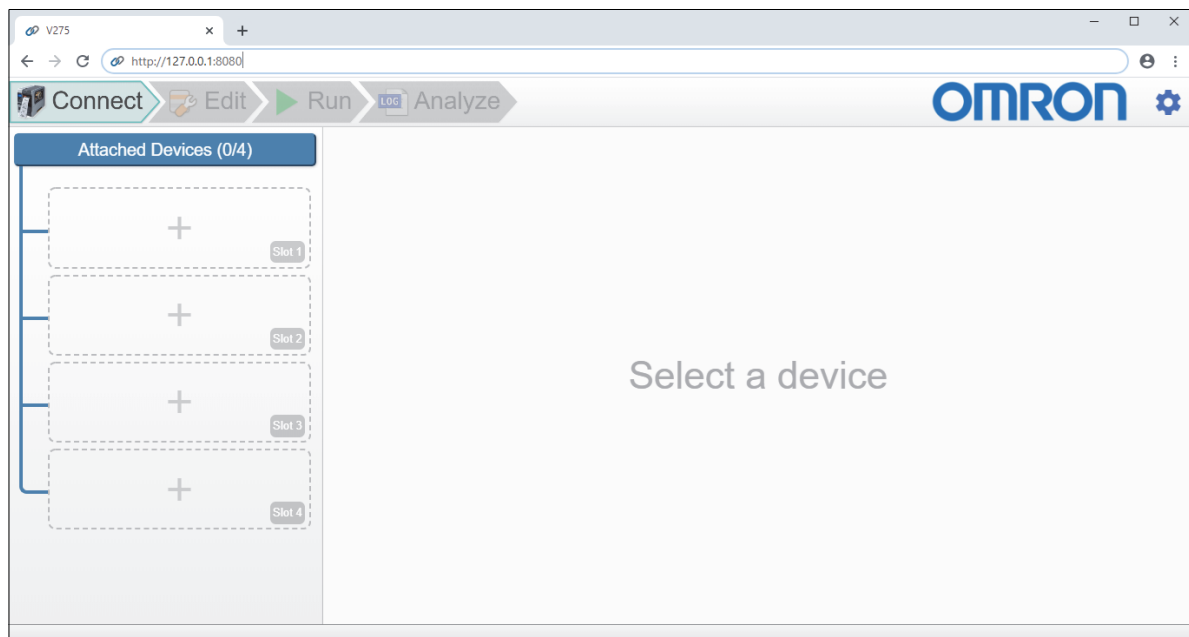

The first item to understand and take note of is the **Attached Devices** panel on the left side of the application. The V275 system can support up to four Print Inspection Devices per server. These four slots represent the four devices currently configured for inspecting. This is done to manage and route communication properly for the different devices. You may notice that we connected to the system over port 8080 to launch the webUI. When subsequently accessing the devices in slots 0 to 4 you will be communicating over ports 8081-8084 respectively. The first step to performing print inspection is to add a device to a slot. When adding or removing devices you will be prompted to log in to complete the transaction. Once a device is added to a slot it is persistent in that slot and available for connection until removed.



The next items to note are the device navigation buttons left side of the main application bar and the gear icon on the right side used to access admin and device configuration options. You will notice in this example only Connect is available for navigation and if you were to click on the gear icon only Language and the About information would be available. This is because the other features are device specific and require you to first login to the device. This a subtle but important concept to understand. Prior to logging into a device, you are only communicating to the main V275 server where you can add, remove, or select a device to log into. Subsequent device functions require a user to login into and control the specific device.

6-1-2 Attached Devices

Up to four devices can be connected to the server at one time. The **V275 Client** can control a single device at a time, but multiple clients can connect to the same **V275 Server** and control different devices simultaneously.

To control a specific device, select it and log in to that device. Once logged in, you can navigate to the other views and control the operation of that device.

6-1-3 Attached Devices Panel

The **Attached Devices Panel** is used to connect devices to the project.

- 1** From the left-hand panel, select an empty **Slot** field and click the plus sign (+) to attach a device.
- 2** In the **Attach Device** prompt, select the **Available Device** you want to add.

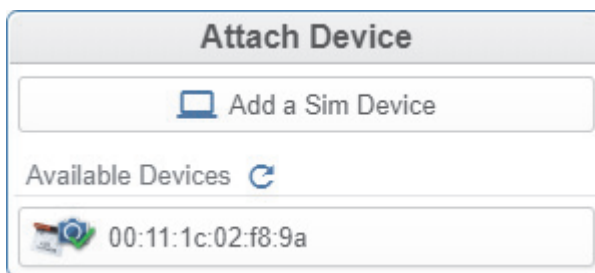

Note: After the device is selected, it will appear in the slot and display its connection status. This device is now available for use.

Note: By default, the device is identified by its MAC address. The default name can be customized by double-clicking on the current name and entering the desired device name.



Note: Click the gear icon from the upper right corner to remove a device.

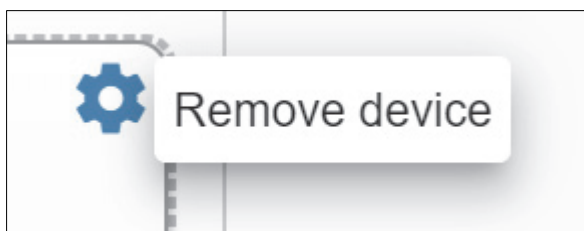

6-1-4 Using a Simulation Device

You can also run V275 Software in **Simulation Mode**.



Click **Add a Sim Device** from the **Attach Device** dialog to begin using a **Simulation Device**.

Simulation Mode allows you to edit and run a job against images contained in the simulation folder found at `\Program Files\v275\data\images\simulation`. Simulation mode can be used for demonstration purposes or to learn system operation if a V275 Hardware system is not available.

Note: A set of simulation images is provided with the V275 installation. These images can be replaced. For best results, simulation images should all be of the same label size and design. They must be in .png, .tif, .jpg, or .bmp format.

If the application is running in Simulation Mode the text “Simulation Mode” will be at the top of the page as shown in the following example.

Note: Calibration and synchronization setup cannot be performed in Simulation Mode.

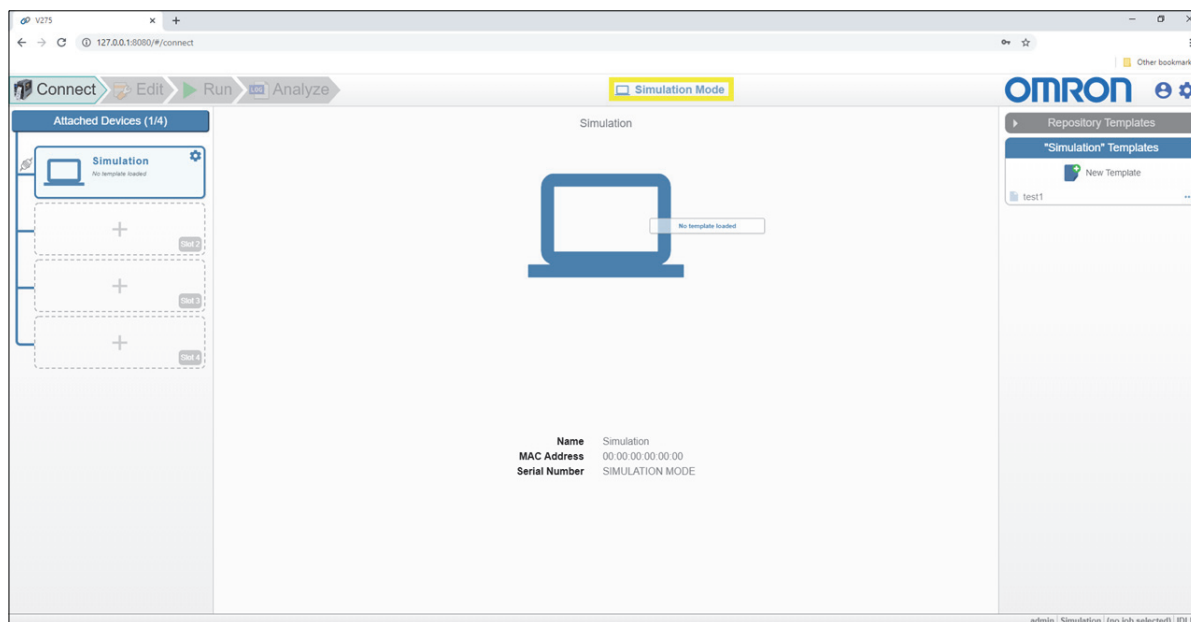

6-1-5 Advanced Session Configuration

The first time a new device is connected to the V275 server the user interface will automatically navigate to the **Calibration Process**. This workflow is only on the initial connection of a device, as the device must be calibrated to perform other inspection operations.

Language, Calibration, Audit Trail, Firmware Update, Device Settings, and About V275 can be accessed by clicking the **gear icon** at the upper right of the user interface.

- **Language** allows you to select the language of the user interface.
- **Calibration** allows you to start, calibrate, or recalibrate the V275 Imaging Device. See **Appendix C** for recommendations on recalibration schedules and see **Section 8** for details of the calibration process.
- **Audit Trail** allows you to view or print the Audit Trail.
- **Firmware Update** allows you to update V275 Imaging Device firmware.
- **Device Settings** allows you to change the **Peel and Present** setting and the **Timeout** period.
- **About V275** displays the **UI version, Runtime version, part number, browser, and OS**.

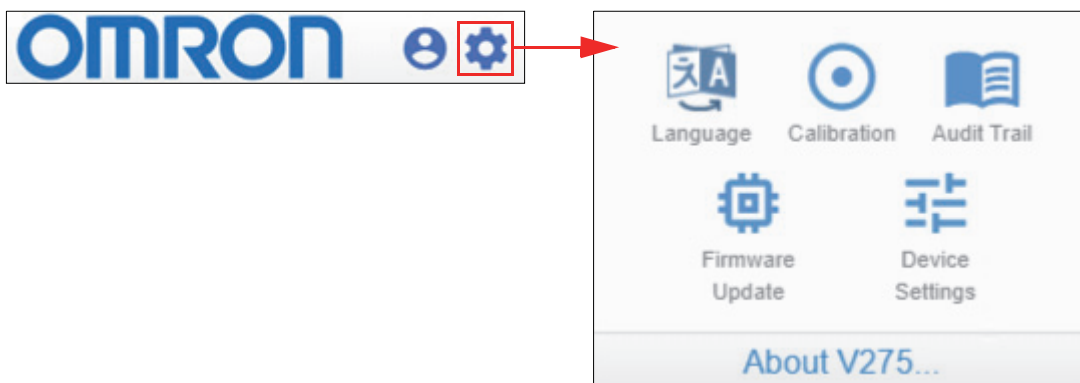

6

6-1-6 Device Status and Template Management

Template management and current device status are the only other functions provided in this main view. After successfully logging into a device the center panel will display the current status of that device and, in addition, the template panel will appear on the right side of the main view and providing access to the templates available for that device. The MAC address is used by default as the name of the device but can be customized by clicking on the current name in the **Connect** panel. The following image shows an example of two devices where the current logged in device is “**Station #1**”.

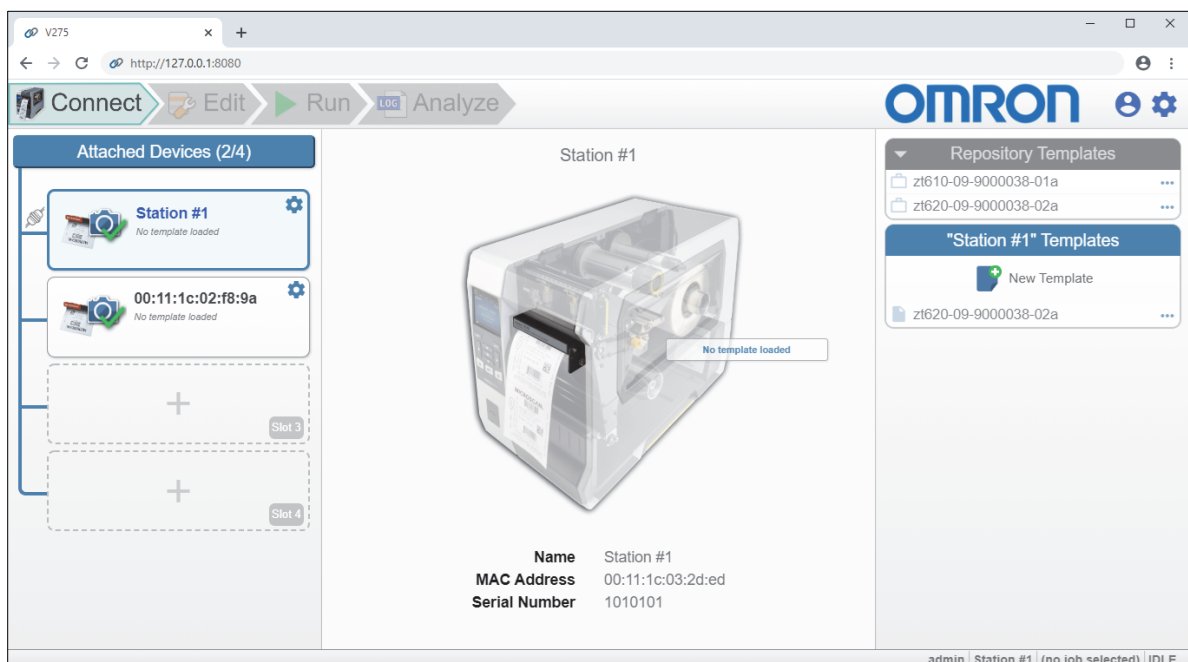



System Administration

This section describes how to add, remove, and configure V275 Software user accounts, as well as how to select the language to use while operating the V275 System.

7-1	Accounts and Permissions	7-2
7-1-1	Administering User Accounts	7-2
7-1-2	Adding a User	7-3
7-1-3	Removing or Modifying a User	7-4
7-1-4	User Permissions	7-5
7-1-5	Permission Enforcement	7-5
7-1-6	Active Directory Configuration	7-5
7-2	Language Selection	7-6
7-3	Peel and Present	7-7

7-1 Accounts and Permissions

The V275 only allows authorized users to access the system. A list of authorized users can be maintained locally on the PC, or they can be configured and authenticated remotely via Active Directory. The default setup is local accounts.

7-1-1 Administering User Accounts

The admin account is the only account that is set up when your system is delivered. A user logged in as an administrator has the authority to add, remove, or edit user accounts. This admin account cannot ever be deleted.

Username: **admin**

Password: **admin**

To access the Admin section, from the top right of the UI, select the User icon and choose **Advanced admin settings**.

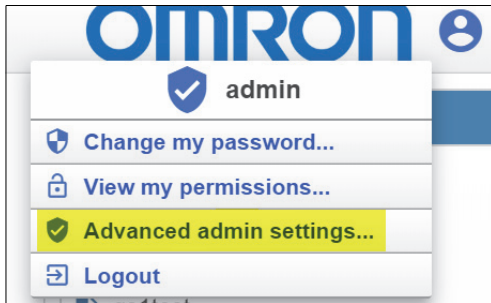

The **Admin** section includes a list of users on the left, and the **Account Management** system settings on the right.

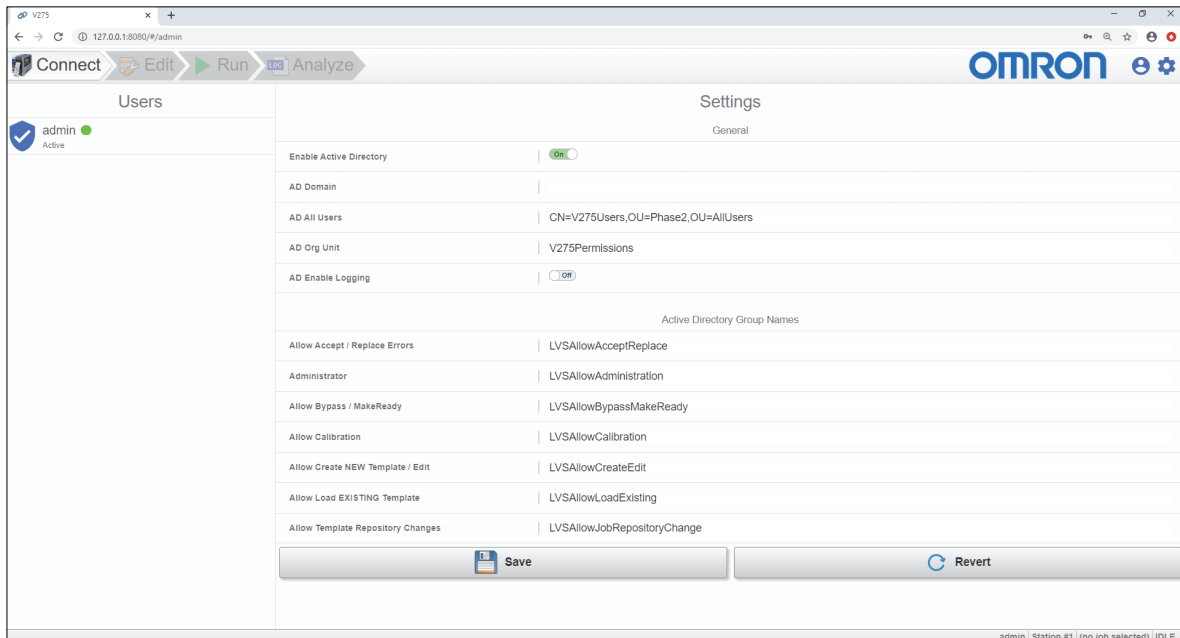

By default, the only account is the admin account.

Enable Active Directory: This turns on Active Directory functionality. When Active Directory is on, user accounts are managed remotely by the customer's IT department. Please see [Appendix G - Using Active Directory](#) for details on how to configure the V275 System to work with Active Directory.

7-1-2 Adding a User

Only an administrator can add a user.

- 1 To add a user, from the bottom of the **Users** panel, click **Add User**.

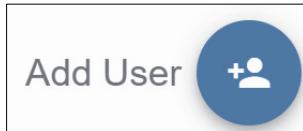

- 2 Enter a username and password for the new user, and select their permissions.

Add User
✕

Enter a username

Enter a username

Enter a password

Enter a new password

Re-enter password

Administrator

Allow Create NEW Template / Edit

Allow Load EXISTING Template

Allow Calibration

Allow Accept / Replace Errors

Allow Bypass / MakeReady

Allow Template Repository Changes

CANCEL
SAVE

- 3 Click **Save**.

Note: The newly added user will be displayed in the **Users** list.

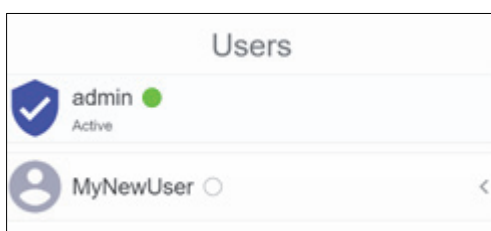

7-1-3 Removing or Modifying a User

To remove or modify a user, place the mouse over any user (aside from the admin) and use the option buttons.

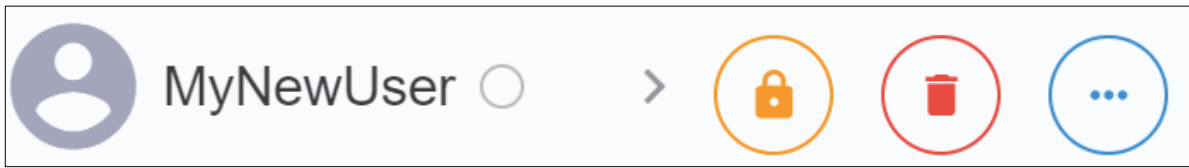

Locks this user's account. The user will no longer be able to log in until the lock is removed.

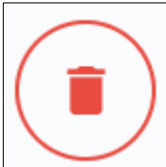

Deletes the account.



Provides account modification options. A context menu will provide the option to change the password on this account and also an option to modify the permissions assigned to this account.

7-1-4 User Permissions

Each user account has a set of permissions assigned to it. These permissions determine the actions allowed and disallowed. User permissions are allocated as follows:

Permission	Description
Administrator	Allowed to add, delete, and edit user accounts. Full access to system.
Job Create / Edit	Allowed to create new jobs and to edit existing jobs.
Job Load	Allowed to perform job changeovers.
Calibration	Allowed to calibrate the system.
Accept / Replace Errors	Allowed to accept and replace label errors.
Bypass / Make Ready	Allowed to run in "Make Ready" (setup) mode.
Abort	N/A
Ignore	Allowed to ignore errors and resume printing.
Reset Printer	Allowed to reset the printer.

7-1-5 Permission Enforcement

A user with limited permissions will be locked out of any areas where they were not given access to when their account was initially set up. For example, a user who was not granted the Template Create / Edit permission would not be able to enter the Setup view, and the navigation button for Setup would be disabled. Their account will display with a lock to provide a visual indication that a specific access type was denied.



7-1-6 Active Directory Configuration

For a detailed description of Active Directory settings and how V275 should be configured in order to support user authentication via an Active Directory server, refer to [Appendix G - Using Active Directory](#).

7-2 Language Selection

- 1 Click the **Settings Icon** (gear) located in the upper-right corner of the V275 interface.
- 2 Click **Language** from the **Settings Menu**.



- 3 Select one of the languages and click **Close**.

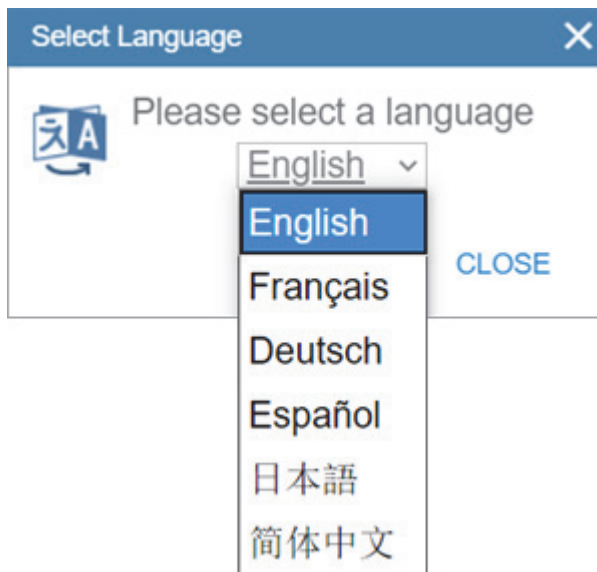

7-3 Peel and Present

If you are using **Peel and Present Mode**, be sure to set the printer applicator setting as indicated in [4-1-3 – Applicator Settings](#) and to load the media and configure the peel bar as described in [4-2-2 – Media Loading When Peeling Labels](#). You will also need to set the Peel and Present setting in V275 software by following these steps:

- 1** Click the **Settings Icon (gear)** located in the upper-right corner of the V275 interface.
- 2** Click **Device Settings** in the **Settings Menu**.



- 3** Click on the **Peel and Present** switch to enable Peel and Present mode in V275 Software.

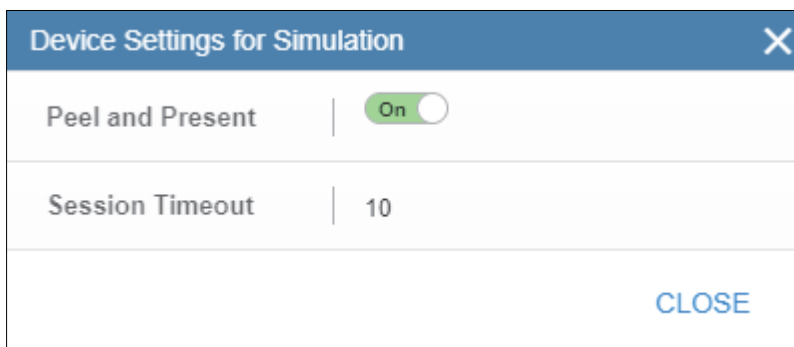

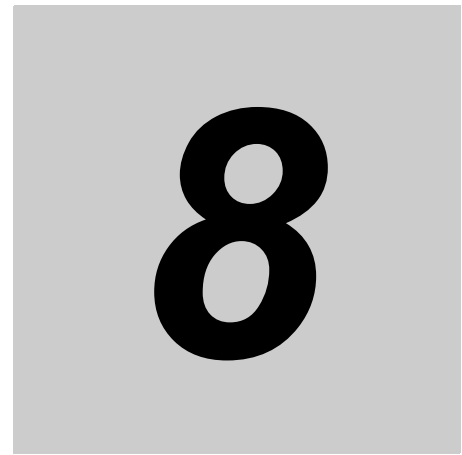

Calibration

This section explains how to calibrate the V275 Print Inspection System.

8-1	Calibrating the V275 Print Inspection System	8-2
8-1-1	Calibration Process	8-2

8-1 Calibrating the V275 Print Inspection System

The V275 Imaging Device must be calibrated in order to produce a uniform image and measure reflectance compliant with ISO standards. To calibrate the V275, you need an Omron Microscan **calibration card** for your specific printer shown below in perfect or near-perfect condition with all calibration information filled out. A calibration card is provided with each V275 System. If the calibration card expires or becomes worn, replacement calibration cards can be purchased from your regional Omron representative.



ZT610 Calibration Card



ZT620 Calibration Card

Important: Successful calibration depends on using a clean calibration card in perfect or near-perfect condition. Omron recommends replacing your calibration card every two years or earlier if it becomes dirty or damaged.

Calibration is required the first time you use a new V275 Print Inspection System. Omron recommends recalibrating the system every time the print ribbon is changed or recalibrating every 2,000 labels if using direct thermal labels.

When connecting to a device for the first time, the user interface will automatically navigate to the **Calibration View** prompting the user to begin the process. When recalibrating the device, you can navigate to the Calibration View through the **Settings** icon (gear) located in the upper-right corner of the V275 interface to the right of the Omron logo and **Admin** icon.



8-1-1 Calibration Process

- 1** Clean the sensor of the imaging device in accordance with [Preventive Maintenance](#) in [Appendix C](#).
- 2** Open the envelope containing the calibration card for your device and remove the card from the envelope without touching the surface of the card.
Important: Always handle the card by its edges.
Note: If this is your first time connecting to this V275 device, the UI will require calibration. The process will automatically jump to **step 7**. **Steps 3 through 6** describe the recalibration process.
- 3** Click on the **Settings** icon (gear) located in the upper-right corner of the V275 interface to the right of the Omron logo and **Admin** icon.

4 Click **Calibration** in the **Settings Menu**.

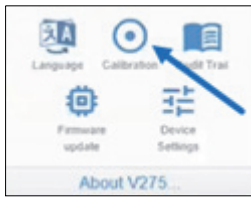

5 Click **BEGIN** to initiate calibration of the device or **EXIT** to return to the previous view.

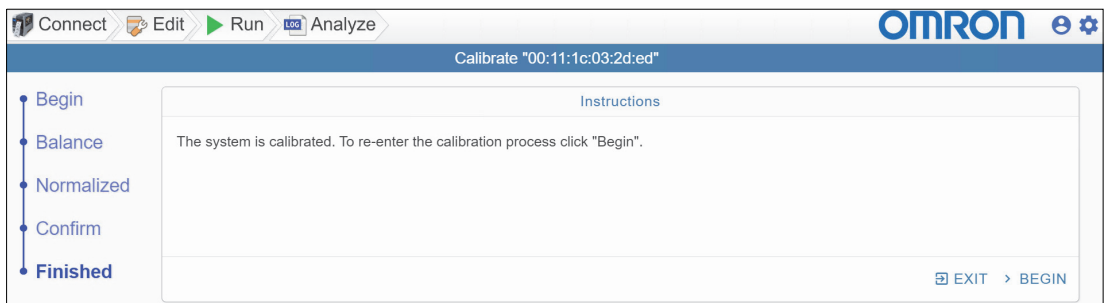

6 Optional: Review the current calibration using the calibration barcodes on the card. To perform this review, follow the instructions to insert the card with the barcodes facing up. Upon proper insertion of the card you will be presented with the results of the current calibration as shown in **step 10**. When ready, or to skip the review process, click **RE-CALIBRATE**.

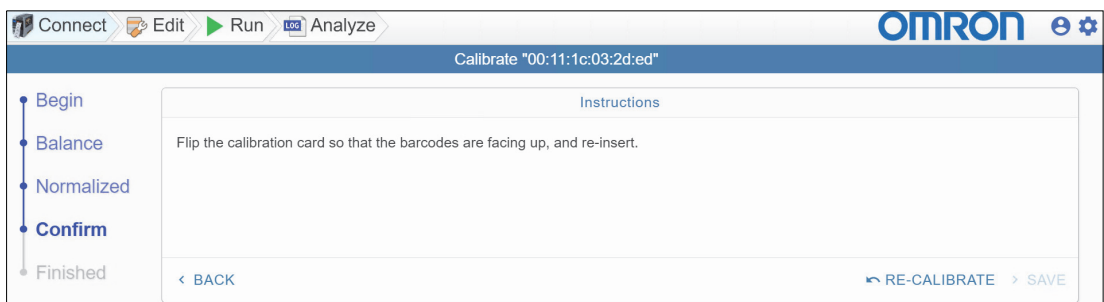

7 Enter the **Contrast** and **R-Max** values printed on your calibration card and insert the card white (unprinted) side up. Be sure the card extends all the way under the device to the print head. To do this properly, lift the imaging device slightly while inserting the card. The card should be inserted above the small silver pin located on the front right side of the device mounting bracket. Once the card is inserted and positioned correctly, click **Begin**.

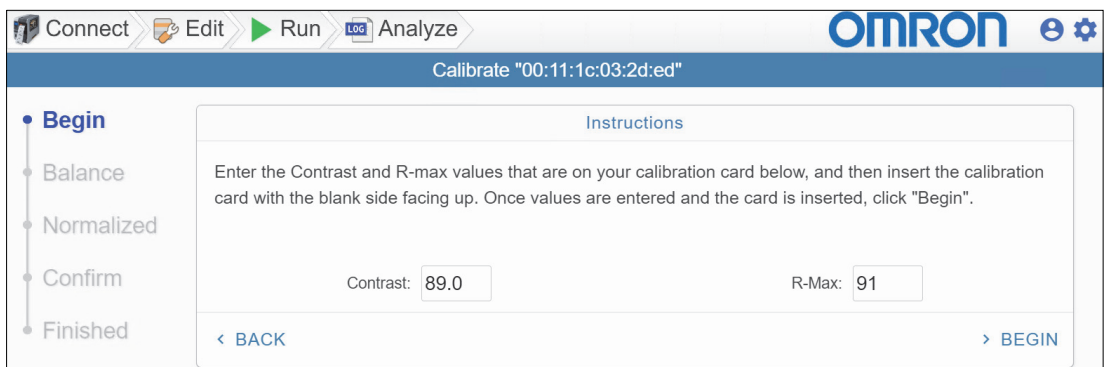

- 8** The device will automatically balance the video once the process has started. This may take a few seconds to complete. If the card or device is moved it may restart balancing as needed. Once stable, you will see a message stating **Video balancing complete**. Click **“Next”** to continue. Click the **NEXT** button.

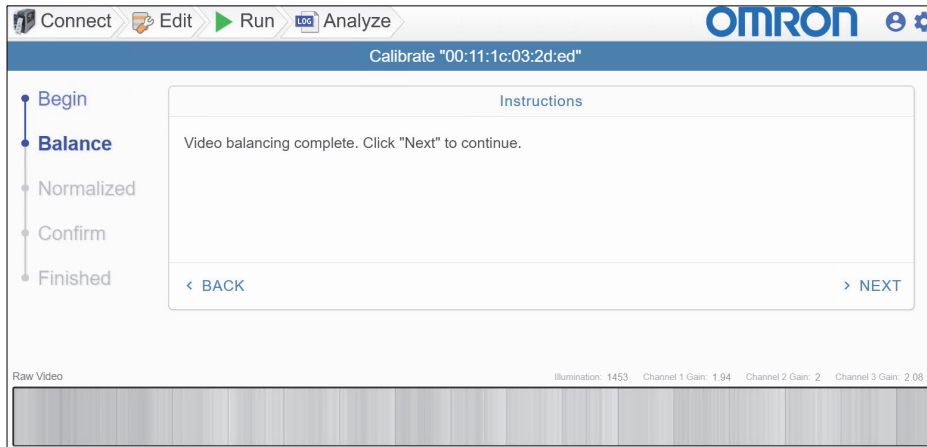

- 9** The process of normalization starts when you click **NEXT**. You will be prompted to remove the card. Carefully place one hand on top of the device, apply gentle pressure, and remove the card with your other hand. The device will complete the normalization process and prompt you to flip the card over. If this process fails, you will need to go back to the **Balance** step and try again.

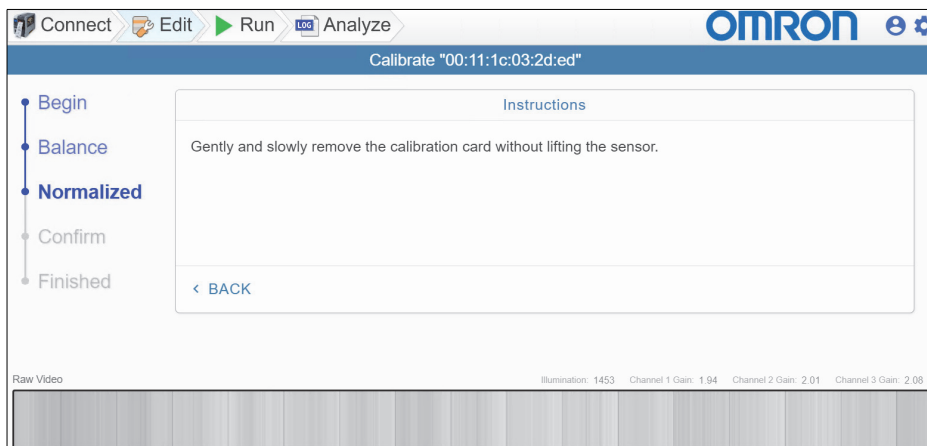

- 10** Successful completion of the **Normalized** step will take you to the **Confirm** step. You will see instructions to flip the card over. Once the card is flipped over and inserted properly you will receive grading feedback in the view. While in this view the system will make minor tuning adjustments. If the system is able to measure acceptable contrast results on the symbol, the **SAVE** button will be active. Ensure all grades are 4.0 and select **SAVE** or click **RE-CALIBRATE** to re-start the process.

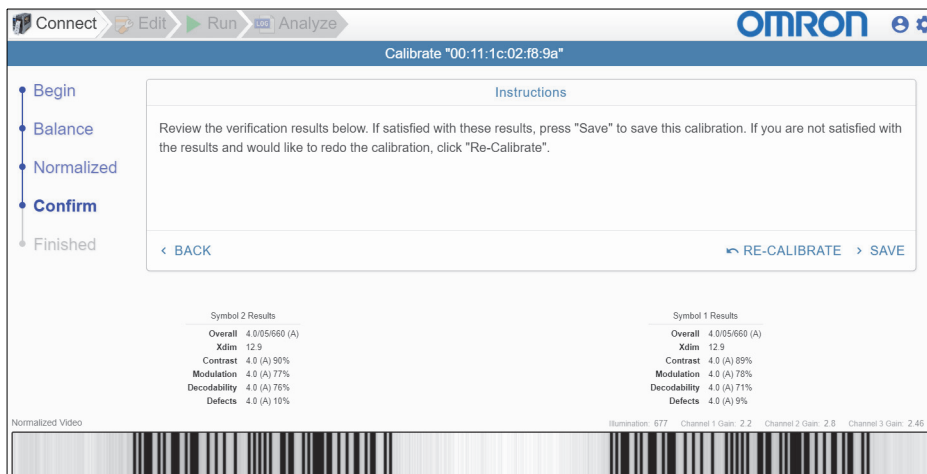

11 The system is now calibrated. Click **EXIT** to return to the main UI.

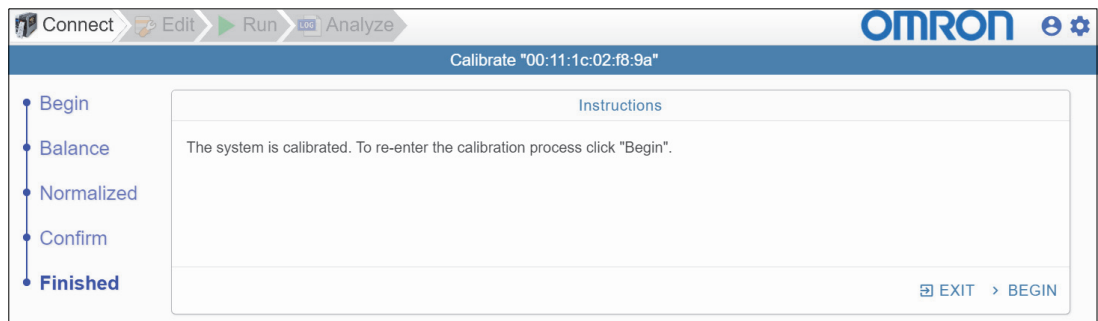

Inspection Templates

An inspection template is a set of instructions that describes how to inspect a given label. You will create a new inspection template for each label you wish to inspect. This section describes how to work with inspection templates.

9-1	Management and Storage	9-2
9-2	Template Basics	9-3
9-2-1	Templates	9-3
9-2-2	Inspection Regions	9-3
9-3	Creating Templates	9-4
9-3-1	Creating a New Template	9-4
9-4	Label Inspection Synchronization	9-5
9-4-1	Synchronization Overview	9-5
9-4-2	Placing the Synchronization Region	9-6
9-5	Auto Setup	9-8
9-6	Edit Screen Components	9-8
9-7	Inspecting Barcodes	9-9
9-7-1	Verify 1D	9-9
9-7-2	Verify 2D	9-11
9-7-3	GS1 / Quality Specification	9-12
9-7-4	Barcode Grading	9-14
9-8	OCR and OCV	9-15
9-8-1	Font Selection	9-15
9-8-2	Read Mask and Touch Mode	9-16
9-8-3	Preprocessing Options	9-17
9-8-4	Font Editor	9-17
9-8-5	OCV	9-20
9-9	Data Matching	9-21
9-10	Blemish Inspection	9-24
9-10-1	Golden Image	9-24
9-10-2	Adding / Re-Sizing a Blemish Region	9-24
9-10-3	Blemish Editor	9-26
9-10-4	Layers	9-27
9-10-5	Tools	9-27
9-10-6	Clearing Layer	9-29
9-10-7	Undo / Redo	9-29
9-10-8	Blemish Parameters – Training Settings	9-29
9-11	Alarms / Outputs	9-30
9-12	Live Results	9-31
9-13	Editing	9-32
9-13-1	Reviewing Read Errors	9-32

9-1 Management and Storage

Templates are stored either in device-specific storage, server-specific storage, or both. When a template is created, it is saved in a location on the server that is specific to the V275 device used to create the template. The template can be made accessible to other V275 devices on the same server by copying it to the Repository. The Repository can be accessed by any V275 device connected to that V275 Server, but cannot be accessed by V275 devices connected to a different server. Moving templates from one V275 Server to another is a manual process.

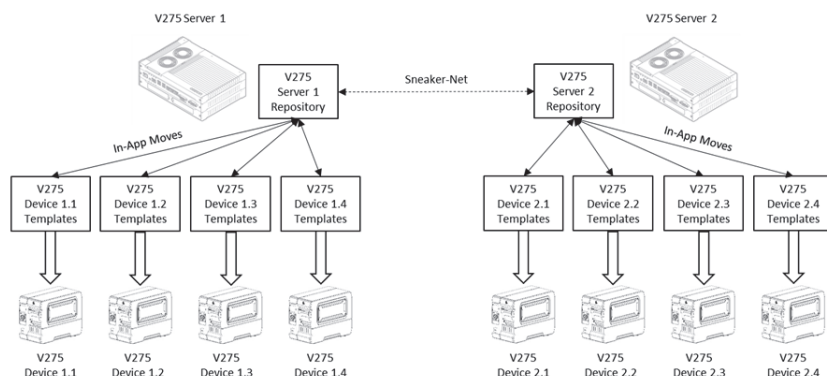

To copy a template from device-specific storage to the Repository, click on the ellipsis button next to the template name and select **Copy to Repository**.

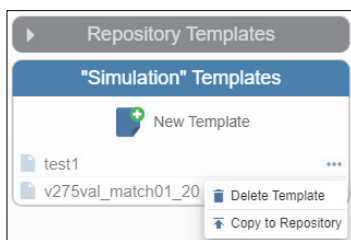

After copying the template to the Repository, it will appear in both places. It will still be available to the connected device.

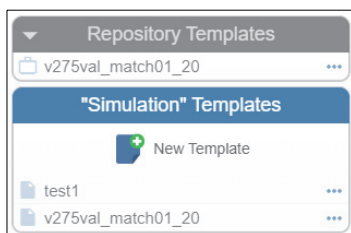

To use this template on a different device, once you are logged into the device to receive the template, click on the ellipsis button for the template name in the **Repository Templates** list and select **Copy from Repository**.

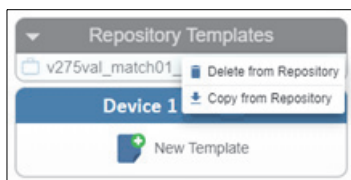

To use templates designed on a V275 Print Inspection Server PC on a different V275 Print Inspection Server PC, you must perform a manual copy of the template from one Job Repository to the other. After connecting to a V275 Imaging Device and designing the template, copy the template to the Job Repository as described above. Navigate to the Job Repository on the source Server located at **C:\Program Files\v275\data\JobRepository**, select the folder with the desired template name and copy the entire folder to the **C:\Program Files\v275\data\JobRepository** location on the target V275 Server.

9-2 Templates

9-2-1 Templates

Templates provide the instructions necessary for the V275 Print Inspection System to perform quality inspections on a label. A template consists of inspection regions with specific acceptance criteria.

9-2-2 Inspection Regions

Inspection Regions define an area within the image where a specific type of inspection is to occur. The inspection type can be for 1D barcodes, 2D symbols, blemish (cosmetic) defects, optical character recognition (OCR) or optical character verification (OCV).

All inspection regions have certain attributes in common.



- **Direction Arrows:** Indicate the direction in which the symbol is read. Applies to 1D barcodes, OCR and OCV regions.
- **Read Result:** Indicates the value read from the region. Applies to 1D barcodes, 2D symbols, OCR and OCV regions.
- **Delete Control:** Allows deletion of the region from the template.
- **Rotate Control:** Used to change the direction that the barcode or text is read.
- **Size Handles:** Allows adjusting the size and shape of the region.

9-3 Creating Templates

9-3-1 Creating a New Template

- 1** Log into the target V275 Imaging Device through the attached devices panel.
- 2** Load your printer with the correct label stock.
- 3** Click **New Template** in the Template pane.

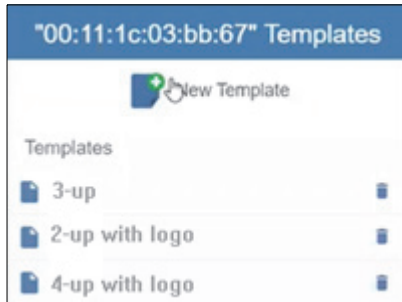

- 4** Enter a new name for your template, and then click Create.

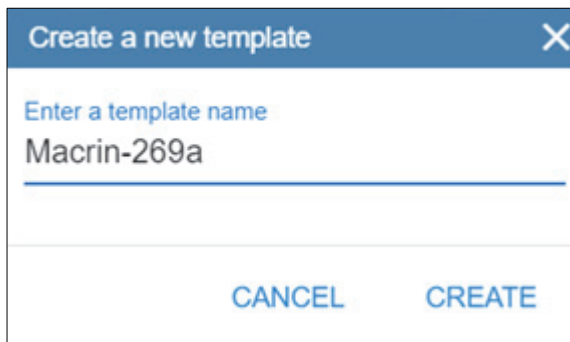

Template names must follow these rules:

- Length <= 32 characters;
- Allowed characters: Alphanumeric, space, hyphen, and underscore;
- Template name must start with a letter.

- 5** You will then be taken to the Synchronization interface described in the next section.

9-4 Label Inspection Synchronization

9-4-1 Synchronization Overview

The synchronization process allows the V275 to locate the label within the video stream. The V275 imaging device continuously acquires data as the printer prints. V275 software implements a synchronization process that looks for repeating features to determine exactly where to apply the inspection template. The first step when creating a template is to define a region to be used for inspection synchronization. The V275 UI automatically takes the user to the sync setup view when creating a new template. This view can also be accessed when editing a template by selecting reconfigure sync in the Edit view.

1 Perform Label Synchronization.

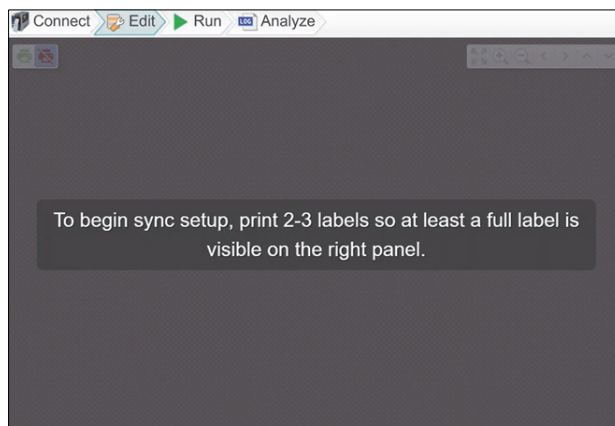

The sync setup screen allows you to choose a unique region on the label that can be used to identify a label within the video stream. See the following section for details.

2 Print a few labels. You may be using label management software to design and print labels. For this manual, we are using a set of labels printed to a PDF file and using the Windows Print function to send them to the printer. In the illustration below, we have selected 5 labels to print. Two to five labels is usually an adequate number of labels for template creation purposes.

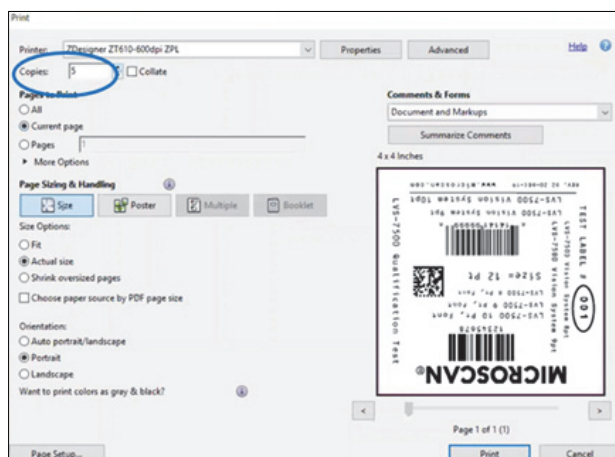

Note: At this point, labels will not print. The V275 will hold the printer in a Paused state until the Activate Printer button is clicked.

3 In the V275, click the **Activate Printer** button.



The labels will start printing and you will be able to see images of the labels in the right side label viewer window.

9-4-2 Placing the Synchronization Region

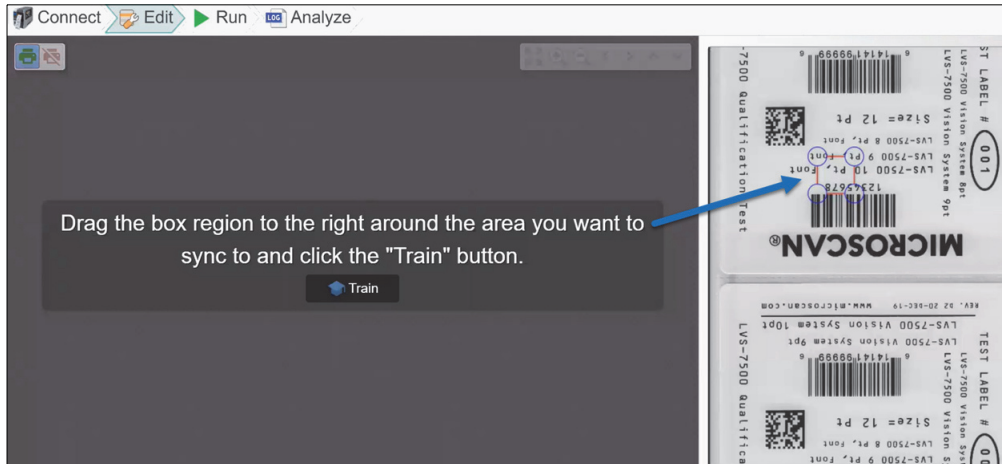

- 1 Drag the synchronization box to surround the region you want to use to synchronize on. The item you select should be something that repeats on each label throughout the label run. It should also be a mark that is distinct from the surrounding markings.

Note: Another criterion to use in selecting the anchor point is that it appears only once per label. A pattern that is repeated more than once on the label may confuse the synchronization algorithm.

The synchronization region can be resized by dragging the handles. The synchronization region needs to be large enough to enclose a unique area of the label, but not too large. A large synchronization area can slow down image acquisition.

In the image below, the “MI” in MICROSCAN has been selected as the synchronization region. This part of the label repeats without change on all labels in the run and is distinct from all other areas of similar size on the label.

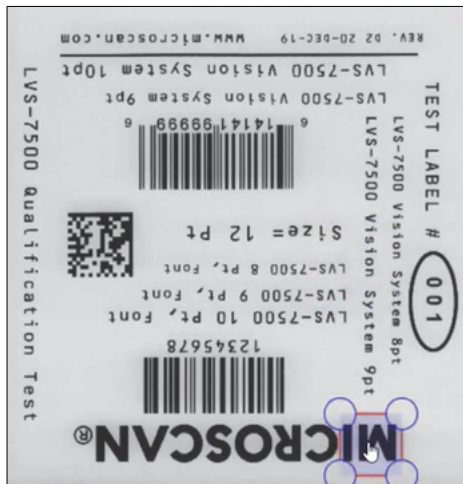

See [Appendix F - Tips and Troubleshooting](#) for hints on selecting the synchronization region for labels with a lot of repeated patterns.

- 2 Once a suitable synchronization region has been selected, click the **Train** button.

- 3** Now, using your mouse, left-click to drag the highlighted area in the right pane, moving it up and down until you've selected a full label between the green lines.

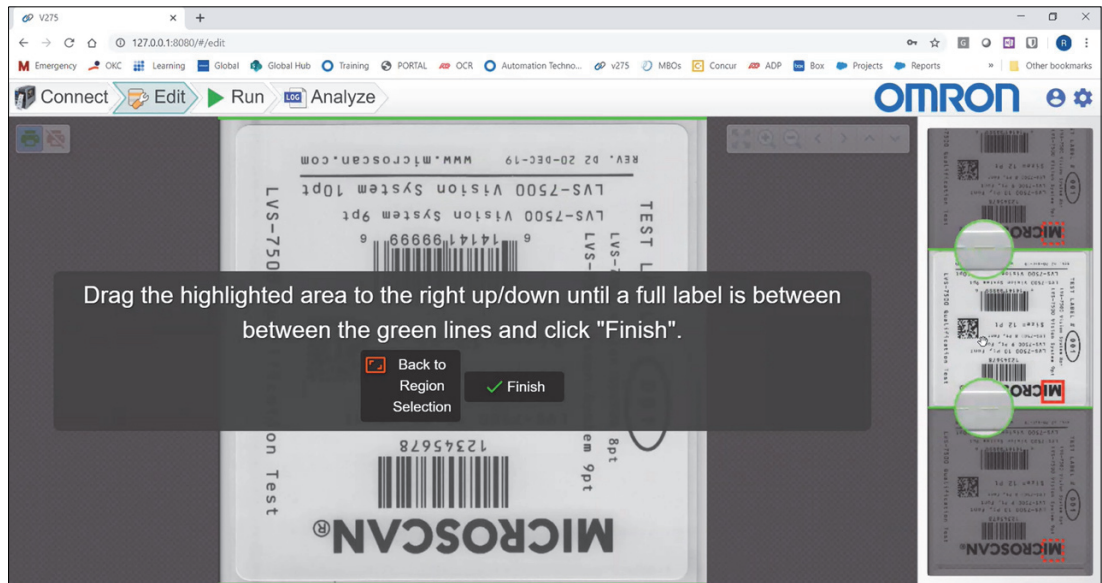

Notice how the edges of the label are magnified so you can see the perforations at the bottom and the top of each label.



- 4** Click **Finish**.



You are now ready to start editing the template to create areas on the label to be validated.

9-5 Auto Setup

Auto setup is automatically performed when creating a new job immediately after the label is synchronized. It will add regions for all 1D and 2D codes that the auto setup process finds and with the correct orientations. This operation can also be manually performed on the current setup inspection image. Note that if you reposition or rotate any of the regions that auto setup finds and you re-initiate auto setup, it will find those codes again and add new regions. Some limitation may apply during auto setup please reference the following sections.

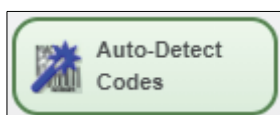

Note: Auto-Detect will not automatically enable GS1 Validation for GS1 symbols. GS1 Validation must be manually configured after detecting or placing the verification region.

9-6 Edit Screen Components

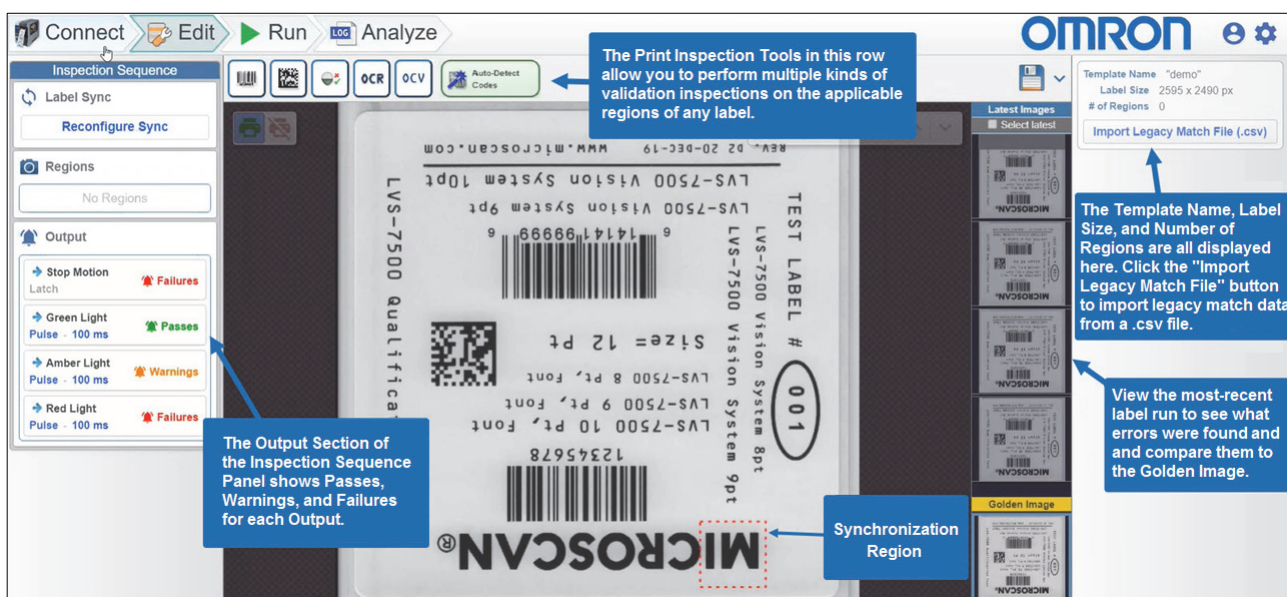

9-7 Inspecting Barcodes

9-7-1 Verify 1D



Use the **Verify 1D Tool** to grade 1D barcodes. Use your mouse to drag the tool from the tool bar to the region of the label that contains the 1D barcode to be graded. Use the handles at the corners of the 1D region to resize it. Be sure to size the region to include enough space for the required quiet zone for the symbology. The 1D region can be repositioned by grabbing it with the hand pointer and dragging it to the required location.



Note: Most 1D barcodes will be auto-detected by the **Auto-Detect Tool**. The Auto-Detect Tool will automatically create a region large enough to include the required quiet zone.

Supported 1D and Stacked 1D Symbols

The 1D verification inspection region supports the various symbologies and symbols listed in following table. Once an inspection region has been created and a code has been detected it will only verify symbols that fall into the same symbology category as the detected code.

Symbology Category	Supported Symbologies	Orientation Required	Auto-Detect
Automatic	All supported 1D symbologies	Yes	--
Code 128	Code 128	Yes	Yes
Code 93	Code 93	Yes	Yes
Code 39	Code 39	Yes	Yes
Codabar	Codabar	Yes	Yes
ITF	ITF	Yes	Yes
UPC / EAN	EAN 13*	Yes	Yes
	UPC-A*	Yes	Yes
	EAN 8	Yes	Yes
	UPC-E	Yes	Yes
	Main + 2 Digit Supplemental	Yes	No**
	Main + 5 Digit Supplemental	Yes	No**
MSI	MSI	Yes	No
PDF	PDF417	Yes	Yes***
	MicroPDF417	Yes	Yes***
	Composite CCA/CCB/CCC Components	Yes	No
DataBar-14	DataBar-14	Yes	Yes
	DataBar Truncated	Yes	Yes
	DataBar Omnidirectional	Yes	Yes
	DataBar Stacked	Yes	Yes***
	DataBar Stacked Omnidirectional	Yes	Yes***
DataBar Limited	DataBar Limited	Yes	Yes
DataBar Expanded	DataBar Expanded	Yes	Yes
	DataBar Expanded Stacked	Yes	Yes***

* UPC-A is a subset of symbols within EAN 13. If the symbol inspected is a valid UPC-A it will report as UPC-A.

** Supplemental codes can be inspected when the region includes it appropriately. The supplemental code will not be included in the region when auto detection is used.

*** Auto detection of stacked symbols can fail to properly configure the entire inspection region and may need be adjusted manually. Auto detection with multiple stacked symbols in the same symbology may fail to the detect codes entirely.

● **Symbology Selection 1D**

A selected 1D inspection region will allow you to configure the categorical symbology type inspected through its symbology drop down menu. If auto detection is used, or the automatic option is selected (by default on placement), the region will automatically configure the symbology parameter. Once configured, only symbols that fall into the configured symbology category defined in the table above can be inspected in that region without changing the configuration.

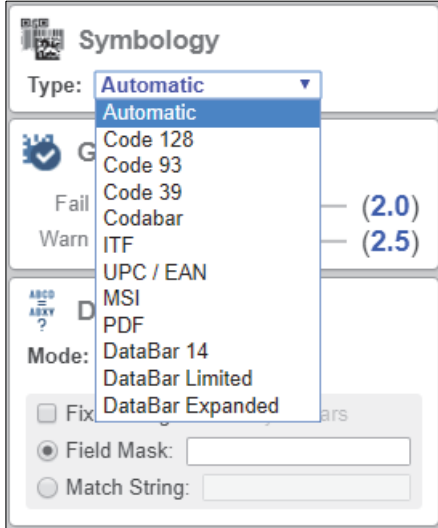

● **1D Orientation**

When creating a 1D inspection region manually, the barcode may not initially grade or read because the reading direction is set incorrectly. In this case, the bounding box for the region will be red. Arrows along opposite sides of the bounding box will indicate the direction of reading. In this example, the arrows point backwards to the true reading direction of the barcode.

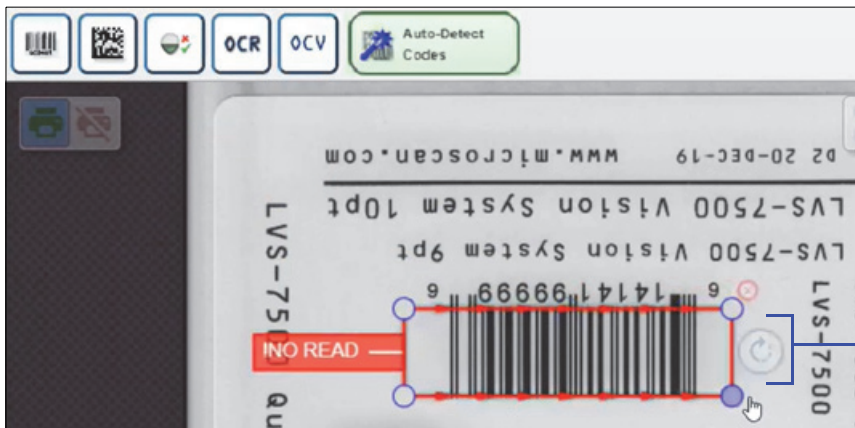

Use the circular arrow to the right of the bounding box to change the direction of reading. Each click on the circular arrow will change the reading direction by 90 degrees.

Use the circular arrow to the right of the bounding box to change the direction of reading. Each click on the circular arrow will change the reading direction by 90 degrees. Often, when the correct reading direction is indicated, the bounding box will turn green. If the bounding box stays red, this indicates there are other errors encountered while reading or grading this barcode.



9-7-2 Verify 2D



Use the Verify 2D tool to grade 2D symbols. Use your mouse to drag the tool from the tool bar to the region of the label that contains the 2D symbol to be graded. Use the handles at the corners of the 2D region to resize it. Be sure to size the region to include enough space for the required quiet zone for the symbology. The 2D region can be repositioned by grabbing it with the hand pointer and dragging it to the required location.



Note: Most 2D symbologies will be auto-detected by the Auto-Detect tool. The Auto-Detect tool will automatically create a region large enough to include the required quiet zone.

● Supported 2D Symbols

The 2D verification inspection region supports the various symbologies listed in following table. Once an inspection region has been created and a code has been detected it will only verify symbols that fall into the same symbology category as the detected code.

Symbology Category	Supported Symbologies	Orientation Required	Auto-Detect
Data Matrix	Data Matrix	Yes*	Yes
QR Code	QR Code	No	Yes
	Micro QR Code	No	Yes
Aztec Code	Aztec Code	No	Yes

* Data Matrix requires the orientation to be provided. When using auto-detection the orientation is automatically configured. Use the orientation feature on the region to change the orientation in the same as is done for the 1D Symbols.

● **2D Symbology Selection**

A selected 2D inspection region will allow you to configure the categorical symbology type inspected through its symbology drop down menu. If auto detection is used, or the automatic option is selected (by default on placement), the region will automatically configure the symbology parameter once a symbol is successfully inspected. Once configured, only symbols that fall into the configured symbology category defined in the table above can be inspected in that region without changing the configuration.

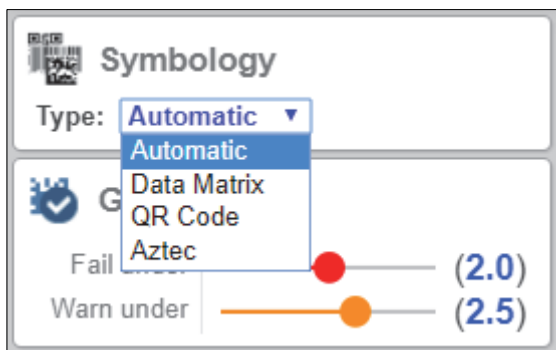

9-7-3 GS1 / Quality Specification

For GS1 codes, the V275 allows users to define which quality spec table will be used when grading and parsing that particular region. The quality specification table is configured in the “Quality Specification” step which is found on the right panel of the Edit view when a 1D or 2D region is selected, as shown below.

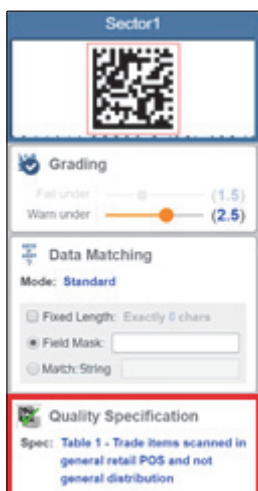

ISO/IEC 15415/15416 is selected by default. To perform GS1 Verification, select the appropriate GS1 specification table in the Quality Specification dropdown menu.

ISO/IEC 15415/15416 (Default)
Table 1 - Trade Items scanned in general retail POS and not general distribution
Table 2 - Trade Items scanned in general distribution only
Table 4 - Trade Items not scanned at POS or general retail - also not scanned in general distribution or regulated healthcare (retail or non-retail)
Table 5 - Logistic units scanned in general distribution
Table 6 - Regulated healthcare non-retail consumer trade items not scanned in general distribution
Table 7.1 - Direct part marking
Table 7.2 - Direct part marking
Table 7.3 - Direct part marking
Table 7.4 - Direct part marking
Table 8 - Trade Items scanned in retail pharmacy and general distribution or non-retail pharmacy and general distribution
Table 9 - GS1 keys GDTI, GRM, GAI and GLN
Table 10 - Regulated healthcare retail consumer trade items not scanned in general distribution
Table 11 - GS1 GSRNs
Table 12.1 - (Trade Items) Tobacco trade items and logistics units for European Regulation 2018/574 on technical standards for the establishment and operation of a traceability system for tobacco products
Table 12.2 - (Trade Item Groups) Tobacco trade items and logistics units for European Regulation 2018/574 on technical standards for the establishment and operation of a traceability system for tobacco products
Table 12.3 - (Logistic units) Tobacco trade items and logistics units for European Regulation 2018/574 on technical standards for the establishment and operation of a traceability system for tobacco products

The tables shown will be filtered based on the symbology of the currently selected region. If no symbology has been identified, only ISO will be an option.

Once a table is selected, the parsed decode text will be display both above in the region in the image display, and in the region box in the left-hand panel of the edit view:

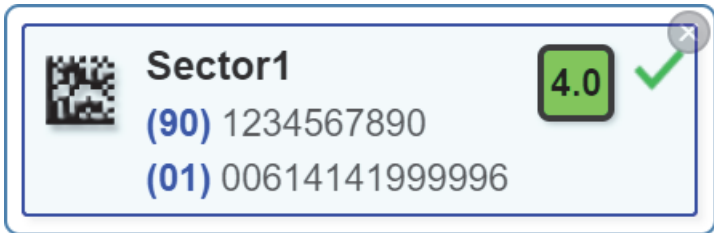

Hovering over the blue tags / IDs will pop up a tooltip describing the field:

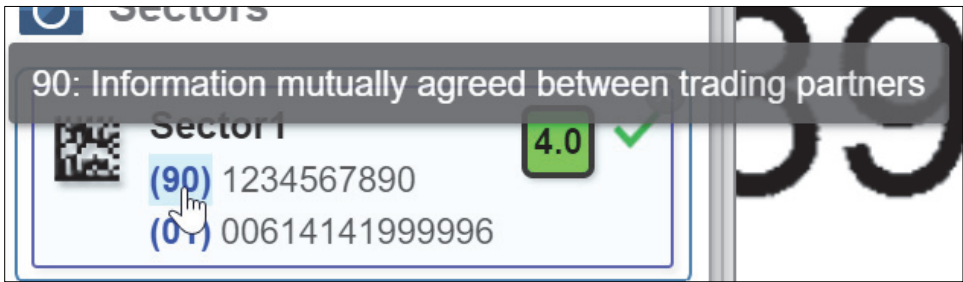

Clicking on the grade will bring up a grading detail dialog as shown below.

1D:

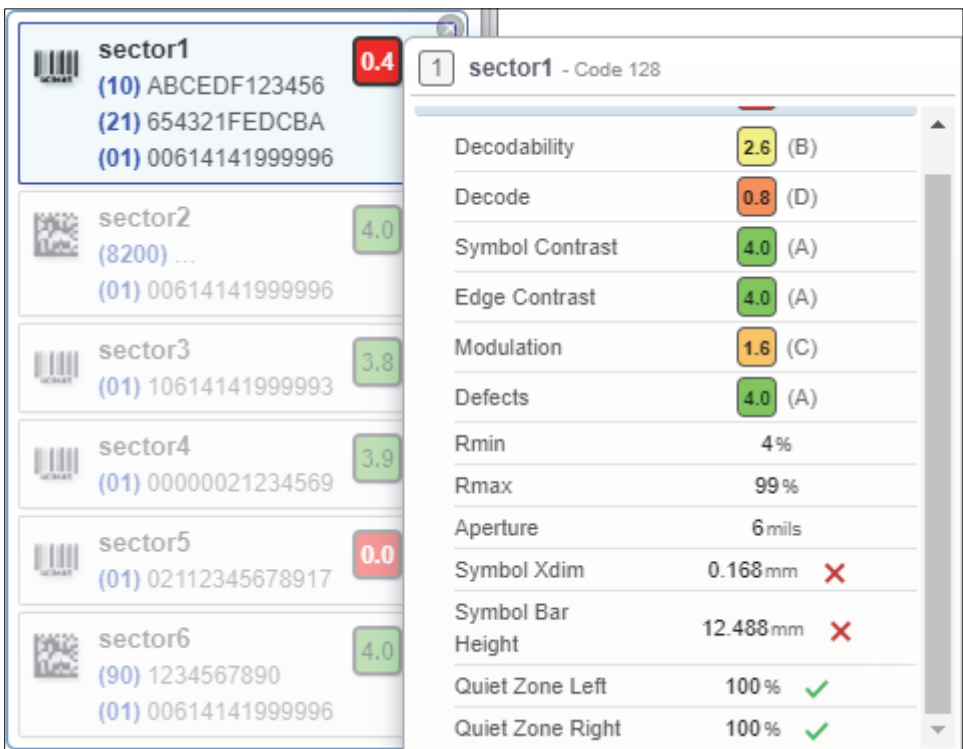

2D:

Parameter	Value	Grade
Unused Error Correction	4.0 (A)	4.0 (A)
Fixed Pattern Damage	4.0 (A)	4.0 (A)
Rmin	7%	
Rmax	255%	
Aperture	8mils	
Xdim	19.9mils	
Symbol Width	14.231mm	✓
Symbol Height	14.085mm	✓
Cell Size X	0.508mm	✓
Cell Size Y	0.503mm	✓
Growth X	51%	
Growth Y	50%	
Format Info	40	
Version Info	40	

Parameter	Value	Grade
Aperture	8mils	
Xdim	29.8mils	
Symbol Width	12.954mm	✓
Symbol Height	12.833mm	✓
Cell Size X	0.762mm	✗
Cell Size Y	0.754mm	✗
Growth X	52%	
Growth Y	48%	
L1	4.0 (A)	4.0 (A)
L2	4.0 (A)	4.0 (A)
Quiet Zone L1	4.0 (A)	4.0 (A)
Quiet Zone L2	4.0 (A)	4.0 (A)
Overall Clock	4.0 (A)	4.0 (A)
Track and Solid Area	4.0 (A)	4.0 (A)

9-7-4 Barcode Grading

The LVS V275 Print Inspection System grades all symbologies as specified in ISO/IEC 15415 (2D symbols) and ISO/IEC 15416 (1D barcodes) and in accordance with the appropriate ISO standard for the symbology. The V275 system also applies the standards and methodologies described in ISO/IEC 15426 (Barcode Verifier Conformance Specification).¹

Grade Settings

Fail Under – Set a numeric value for the minimum acceptable grade for the symbol in the selected region. Symbols scoring less than this value will generate a **Failure Alarm** and trigger the actions specified in the **Output** panel. See **Section 9-11** for more information about alarms.

Warn Under – Set a numeric value at which to generate a **Warning Alarm**. A symbol that receives a score less than the **Warn Under** value but greater than or equal to the **Fail Under** value will generate a Warning Alarm. Warning Alarms will trigger the actions specified in the **Output** panel. See **Section 9-11** for more information about alarms.

Note: If it is necessary to create an inspection region for either a 1D code or a 2D code to use for data matching, but it is not necessary to grade the code, set both the **Fail Under** and the **Warn Under** values to **0**. No grading will be performed, but the data encoded in the symbol will be read.

GS1 Errors

If the symbol being graded is a GS1 symbol, additional errors and warnings may be generated.

GS1 Structure Errors – **GS1 Structure Errors** will generate a **Failure Alarm**. A Failure Alarm will trigger the actions specified in the **Output** panel. See **Section 9-11** for more information about alarms.

GS1 Bar Height Errors – **GS1 Bar Height Errors** can be treated as **Failure Alarms**, **Warning Alarms** or **Ignored**. By default, GS1 bar height errors are treated as Failure Alarms. See **Section 9-11** for more information about alarms.

GS1 X-Dimension Errors – **GS1 X-Dimension Errors** can be treated as **Failure Alarms**, **Warning Alarms**, or **Ignored**. By default, GS1 X-Dimension Errors are treated as Failure Alarms. See **Section 9-11** for more information about alarms.

¹ISO/IEC 15426 assumes verification of a pre-printed symbol using a stationary verifier. The conformance criteria are predicated on having a source of truth available. For stationary or handheld verifiers, such as the Omron LVS-95XX series of barcode verifiers, that source of truth is a set of NIST-traceable calibration cards. No such source of truth exists for an in-line print quality inspection system such as the V275. To infer conformance to ISO/IEC 15426, Omron printed and graded a set of labels using a V275 system, then re-graded the same labels using an LVS-9510 desktop verifier. The LVS-9510 verifier was calibrated to fall within $\pm 3\%$ on all parameters specified in ISO/IEC 15426. The LVS-9510 tolerances were added to the ISO/IEC 15426 tolerances when judging the V275 grades compared to the LVS-9510 grades. For this reason, users may see more variance than expected when grading similar symbols using the V275 system.

9-8 OCR and OCV

OCR (Optical Character Recognition) and **OCV (Optical Character Validation)** are related functions that serve distinct goals.

- OCR reads printed text. OCR has no prior knowledge of what the text should be. It provides the best match for each character found from the selected font.
- OCV verifies that the expected characters are present and that they meet application requirements.

9

9-8-1 Font Selection

The OCR/OCV regions identify characters in the image by matching them to the characters of a font. You must choose a font that closely matches the characters on your label for OCR to read effectively. Choose a font by going to the right panel and clicking on the **Font** dropdown.

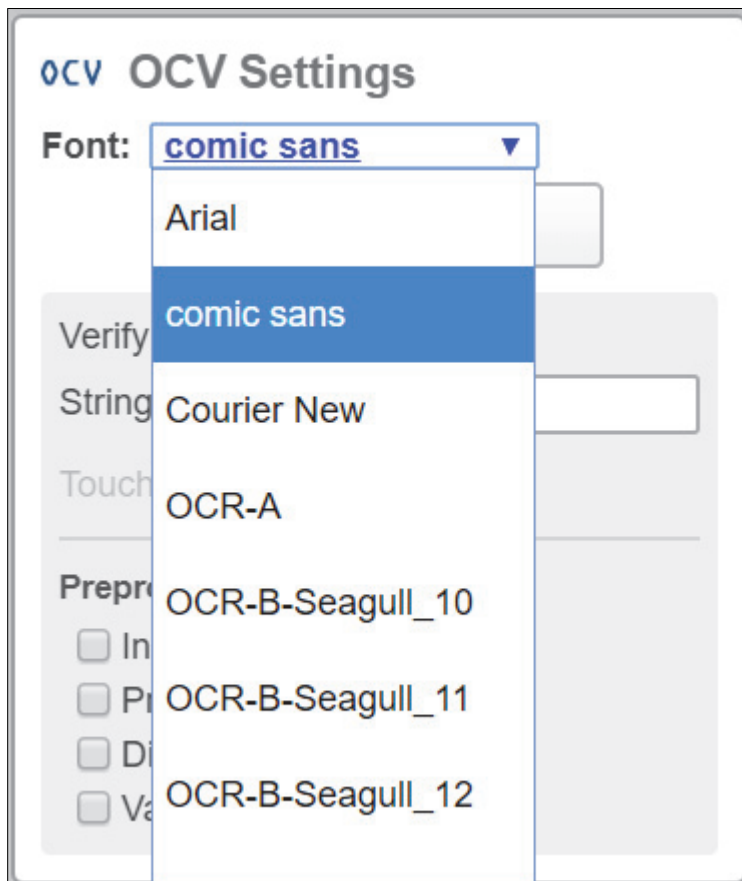

Omron provides a set of commonly used fonts. If none of the fonts are sufficient for your application, you can create your own font or retrain individual characters in an existing font by clicking the **Train Font...** button.

Font: **Arial**

Train Font...

See [Font Editor](#) for details.

9-8-2 Read Mask and Touch Mode

The **Read Mask** can be used to improve read performance by telling the OCR algorithm how many characters to expect and whether each character should be a digit or a letter. A common problem with OCR is confusing the letter 'O' with the digit '0', or the letter 'B' with the digit '8'. The read mask can be used to fix issues like this. Consider the following example:

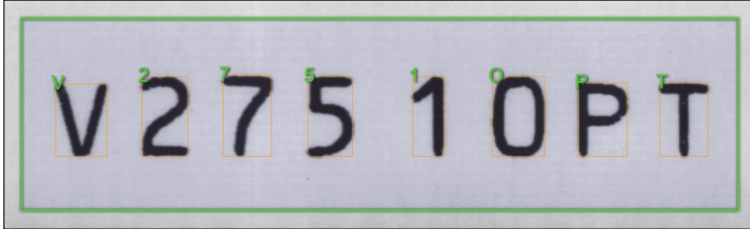

Note that the '0' was read as an 'O'. We can fix this by entering the following Read Mask:

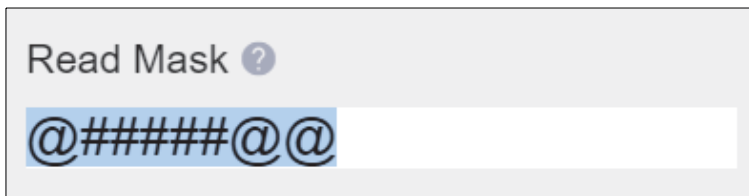

@	Character must be a letter (A-Z).
#	Character must be a digit (0-9).
*	Any character is acceptable.

We told the algorithm that the first character should be a letter, the next 5 should be digits, and then the last 2 should be letters. Now all characters are read correctly:

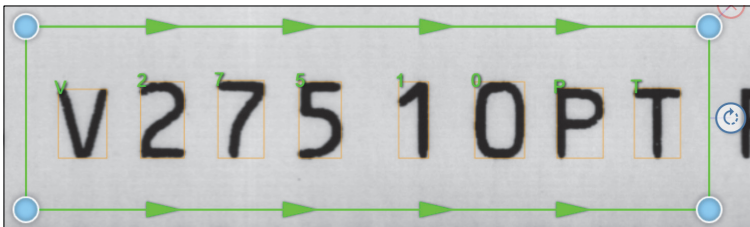

Touch Mode

Touch Mode is only activated when you are using a Read Mask. Touch Mode uses the expected length of the string, and it will use this information to help it separate characters that are touching, or connect characters that have broken apart. Activate Touch Mode by clicking the On/Off switch, and you will be presented with two options:

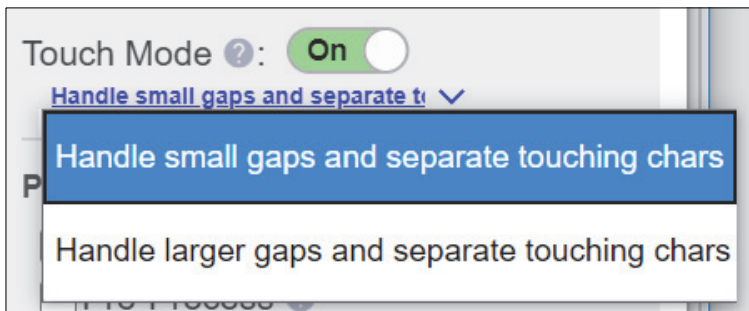

Each of these options will attempt to separate touching characters, and connect characters that have broken apart, but the "Handle larger gaps..." option is simply more aggressive.

9-8-3 Preprocessing Options

Preprocessing Options enhance the image to assist with difficult-to-read text.

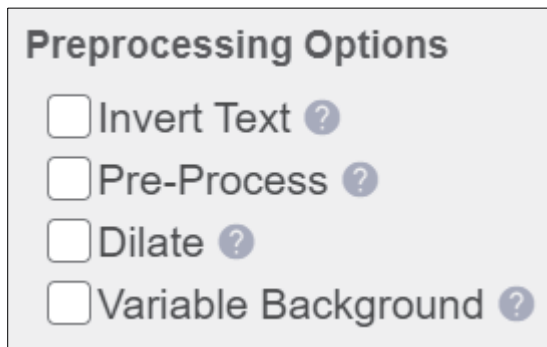

- **Invert Text:** Reads white text on black background.
- **Pre-Process:** Removes noise.
- **Dilate:** Broadens characters before reading.
- **Variable Background:** Makes background contrast more consistent.

9-8-4 Font Editor

The **Font Editor** is used to modify the characters in an existing font, or to create an entirely new font to improve read performance. To open the Font Editor, click “Train Font...” button.

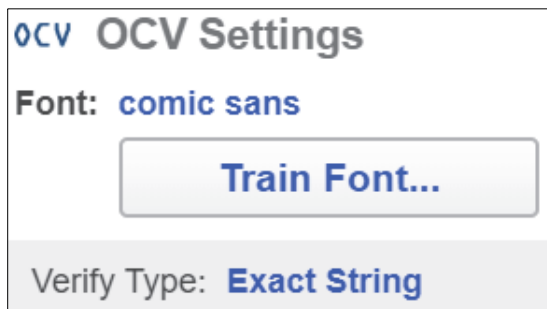

You will be switched to Font Editing mode, and the font editor panel will be displayed at the top of the page with your currently selected font loaded by default. The image display zooms in on the selected region and display a “Characters to Train” popup above the ROI:

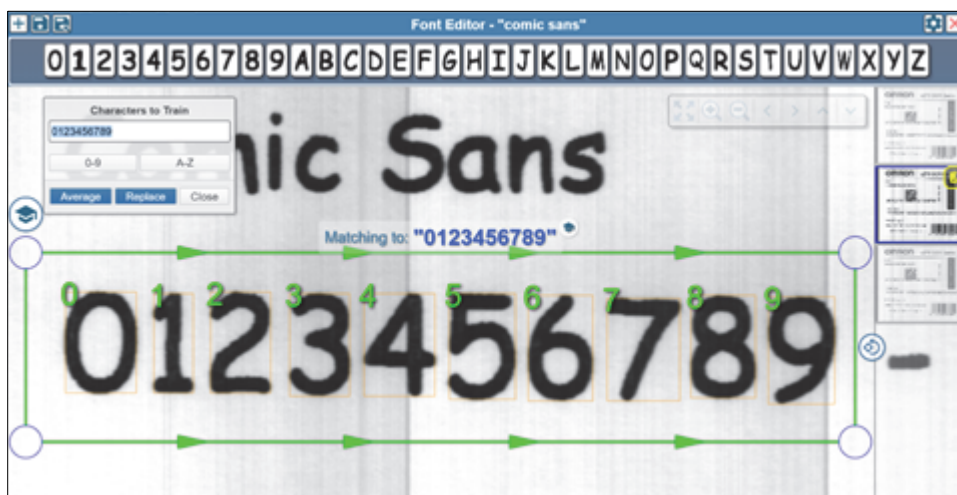

Training a character or characters in a font is a 3-step process:

- 1** Position the ROI over the character or characters to be trained.
- 2** Type those characters into the **Characters to Train** box.
- 3** Click either the **Replace** or **Average** button.

Clicking Average will average the read characters with the character images in the font itself, and Replace will replace the characters entirely with the read characters.

Note: Replace is typically used to replace the character in the font with the image of the character you are training on. Average is typically used for characters that have a lot of variability. Using the Average option to train on multiple examples of a given character may yield a font image that performs better than a font image that was trained on one single character. This makes training more complicated however, as you will need to print out multiple samples of each character.

The UI indicates which characters have been trained by outlining them in red:

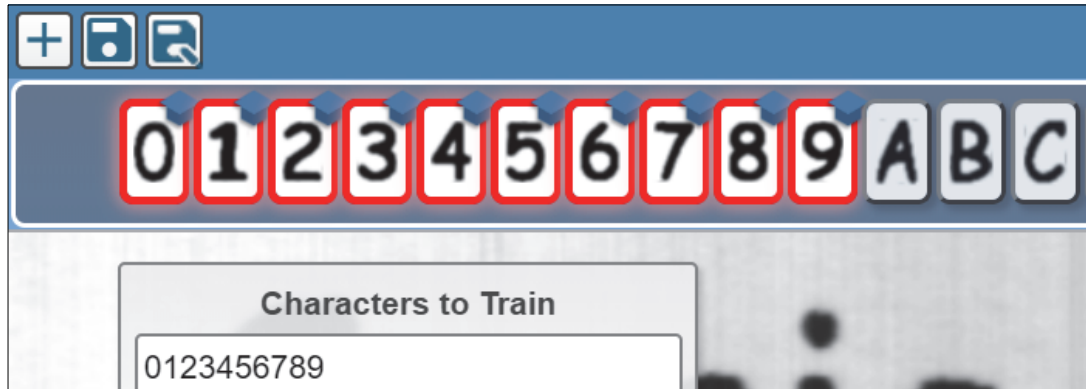

Clicking on an individual character in the font opens up the options to undo the training on that character or clear it entirely:

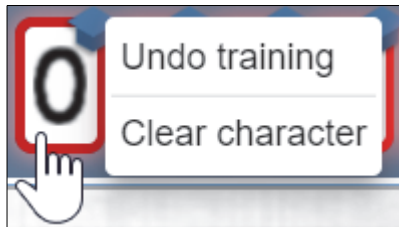

Clicking on the settings icon will present undo / clear / other options for the entire font:

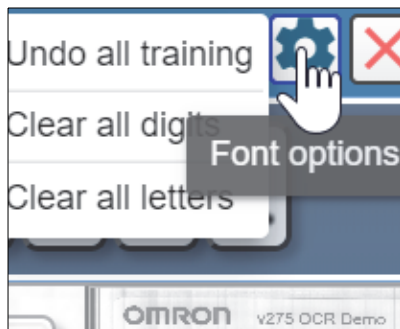

Create a New Font

To create a new font click the **+** icon in the top-left corner of the Font Editor.



Enter a unique name for the font. The font file will be saved with the name you enter, so you must enter a valid Windows file name.

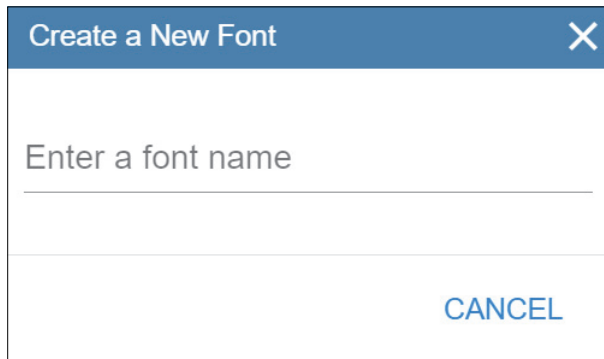

You will be presented with an empty font. You must now train each character.



Save the Font



Click the disk icon to save any changes you make to the font while in the Font Editor.

Save As / Copy Font

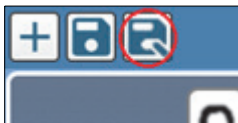

Click the **Save As** icon to save the current font to a different file name. This allows you to make a copy of an existing font. Omron recommends making a copy when you wish to make changes to one of the standard fonts. For example, perhaps you're using the Arial font, and it reads well most of the time, but has trouble with the characters '5' and '0'. Retraining those characters would most likely improve performance. But rather than overwriting the character information in the standard Arial font that provided, you should open the Arial font in the Font Editor, click Save As to make a copy, and then retrain the '5' and the '0' in your new font.

Closing the Font Editor



Click the red X in the upper right of the font editor to close it. If there are unsaved changes to the font when the editor is closed, a dialog will appear asking if the changes are to be saved or discarded.

9-8-5 OCV

The OCV region must always match against a known string. By default, you enter this match string manually, either above the ROI...



Note: You can automatically set the current string to the match string by clicking the graduation cap icon.

...or in the **String** field in the right panel.

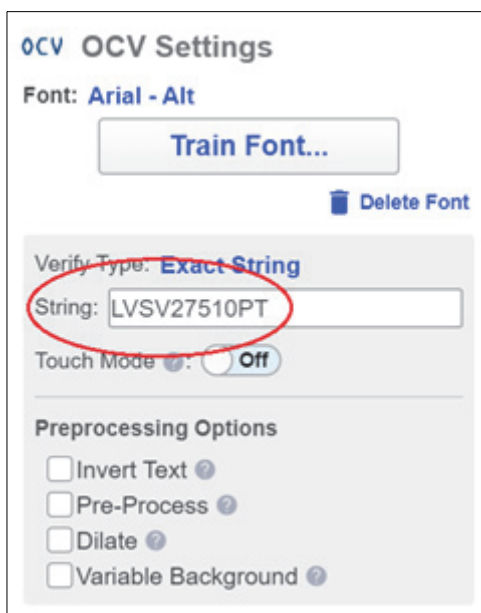

Alternately, you can match to another region or a user-defined data set by changing the **Verify Type**.

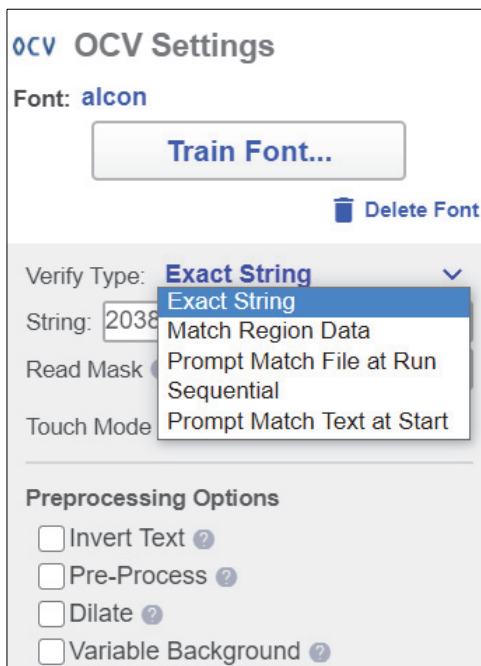

Note: If manually entering the match string, omit spaces. For example, if the string printed on the label is **LVS PRINT QUALITY**, the correct match string is **LVSPRINTQUALITY**.

9-9 Data Matching

Data Matching provides options for matching the 1D barcode, 2D symbol, or OCR output string to a fixed match string, to the read string from another region, or to a string from a master file.

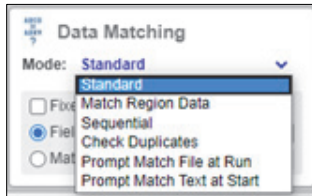

All of the data matching modes provide a Field Mask capability. The field mask instructs the application to look for characters of only a certain type. The following field mask characters are defined:

Field Mask Character	Meaning
@	Character must be a letter (A-Z).
#	Character must be a digit (0-9).

Standard: The default mode, which allows the user to input either field mask or match string, and optionally specify a fixed length. Leaving the Field Mask and Match String fields blank will result in the string being read and logged in the run log with match grades reported. In this case, OCR will only fail if it reads no characters.

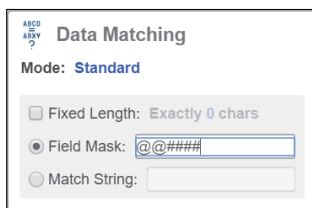

Match Region Data: Matches the output string of the selected region to the output string of another region in your template. In the example below, this region's output text must match Verify1D-2's output text on every inspection.

Note: When matching to region data, the field mask is required. The length of the field mask is used to determine how many characters to extract from the match region.

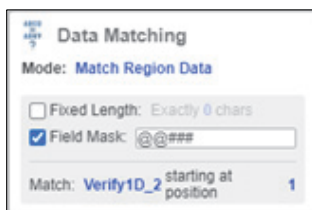

Sequential: This mode checks to make sure that the value of the decoded string either increments or decrements on each label, depending on the option chosen in the **Sequence Mode** field. The step size and base are configurable. For example, if the first string decoded by the region is **12345**, and you've selected **Increment** with a **Step Size** of **1**, then the second label must be **12346**, the third must be **12347**, etc.

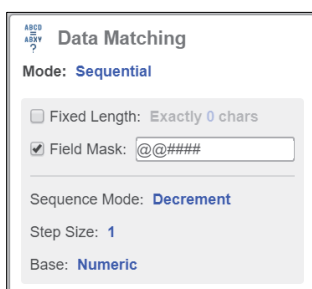

Check Duplicates: In this mode, the region will keep track of every string value that it reads, and it will require that each string value be unique. No duplicates are allowed. This mode will trigger an alarm if any duplicate output data occurs either per repeat, per run, or per template (configurable in the **Duplicates Mode** dropdown). To change the Duplicates Mode, click in the Duplicates Mode field, click the down arrow, and then select the desired mode.

- **Per Repeat:** The scope of the duplicate inspection is limited to the current Repeat. A Repeat is typically identified with a label, but may include multiple labels. This can happen if there is more than one label across the width of the web.
- **Per Run:** The scope of the duplicate inspection is expanded to include all Repeats in the Run.
- **Per Template:** The scope of the duplicate inspection is expanded further to include all Repeats in all Runs using this template.

By default, the **Unique Set Number** is a unique ID for that region, but if set to the same Unique Set Number as another region, duplicates across any of the regions with the same set ID will trigger the alarm.

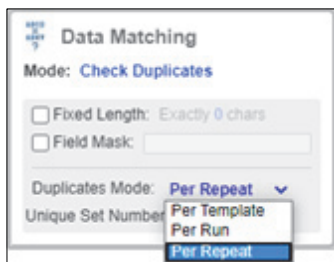

User-Defined Data Set: In this mode, the user can manually specify on which output is expected per repeat. It can either be a repeat -> output mapping (**Sequence Set Type**), or simply a set of values that each repeat must output one of (**Value Set Type**).

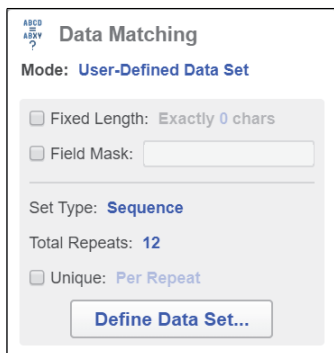

To load the data from a file, click **Load From File (.csv)** and choose the file you want to import. The format of this file should be a value on each new line, e.g.:

```

match-text.csv - Notepad
File Edit Format View Help
4
5
6
4
1
2
3
4
9
8
7
6
    
```

Prompt Match Text at Start: This mode is used when the match text needs to be input manually by the operator for each run, e.g. the current date.

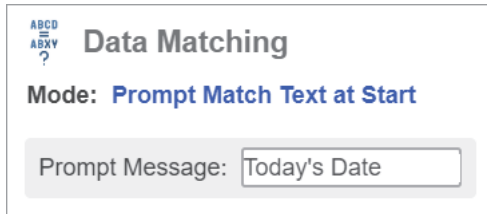

The screenshot shows a configuration window titled "Data Matching". In the top left corner, there is a small logo with the letters "ABCD" above "ABXY" and a question mark below. The main title "Data Matching" is in a large, bold font. Below the title, the text "Mode: Prompt Match Text at Start" is displayed. At the bottom, there is a label "Prompt Message:" followed by a text input field containing the text "Today's Date".

When starting the run, the UI will prompt the operator to enter any pending match prompts.

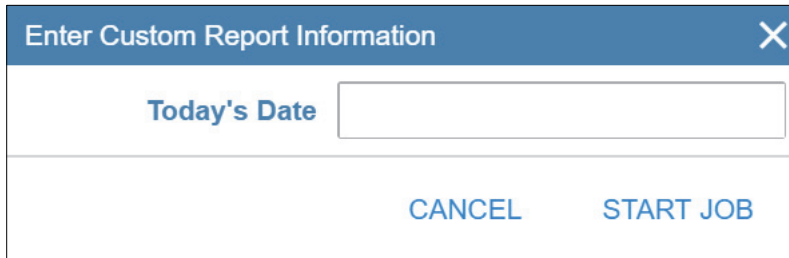

The screenshot shows a dialog box with a blue header bar that says "Enter Custom Report Information" and a close button (X) on the right. The main area of the dialog has a label "Today's Date" followed by a text input field. At the bottom of the dialog, there are two buttons: "CANCEL" and "START JOB".

9-10 Blemish Inspection

9-10-1 Golden Image

Blemish inspection looks for differences in the appearance of a label from a “golden” image. The golden image is defined during the template creation process and is displayed in thumbnail size in the lower right corner of the label view window in the edit screen.

9-10-2 Adding / Re-Sizing a Blemish Region

- 1 From the **Setup** toolbar, click and drag the **Blemish** icon onto the image.



Note: This will create a Blemish region of interest (ROI), and automatically train the background / foreground parts of the mask using default parameters.

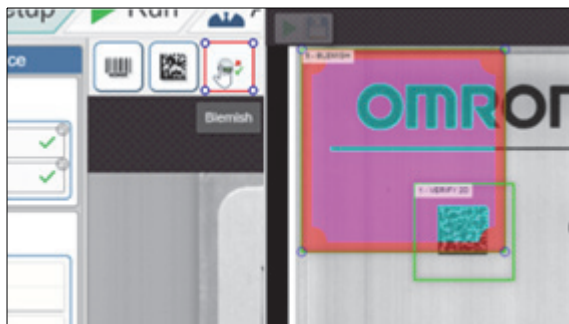

Note: The ROI is the red box shown above.

- 2 To retrain the region, click to resize the ROI.

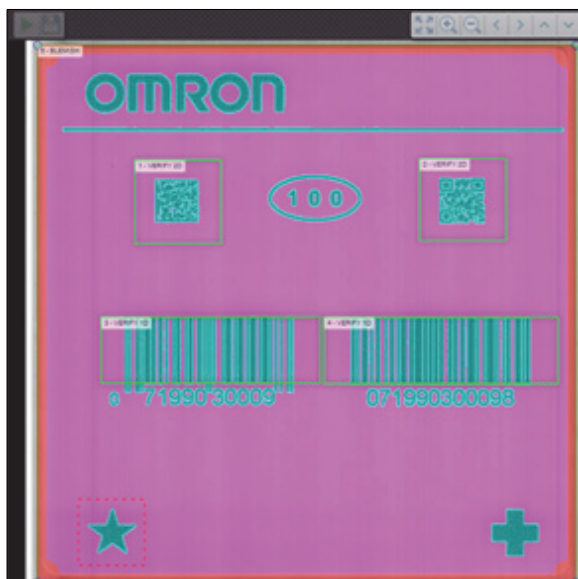

Note: The pink and light blue represent the background and foreground layers respectively.

Important: If a label is inspected and a dark pixel (darker than a user-specified threshold) shows up in an area defined as background (the lighter areas), a Background Alarm will be displayed, and vice versa for Foreground.



Note: The red outline represents the die cut layer, which detects movement of the outside edge of the label.

Re-Sizing a Region

Because blemish regions are mask-based, moving or re-sizing them can cause issues as the existing mask will be disrupted by this movement or may no longer apply to the new location. To help prevent accidental re-training or resetting of the mask, confirm before moving the mask.

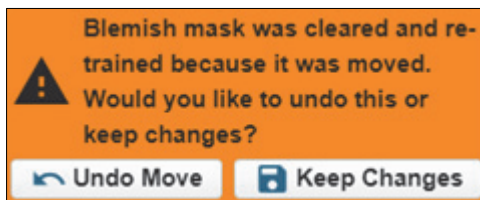

9-10-3 Blemish Editor

Using the Blemish Editor

To View and Edit the Mask:

- 1 Click on the blemish region.
- 2 Click **Open Blemish Editor...** on the right panel



- 3 Use the editing tools listed below to make changes to the blemish, and then click **Close Blemish Editor** when done.

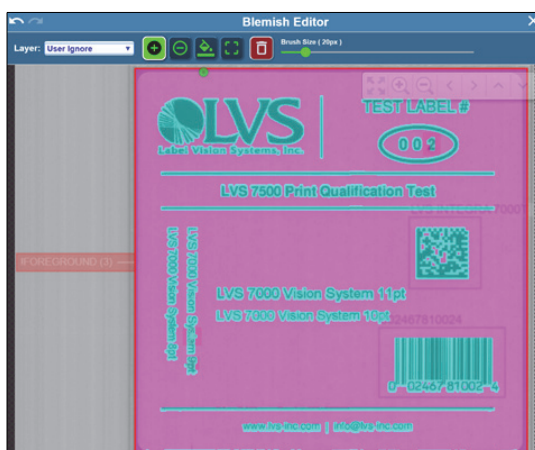
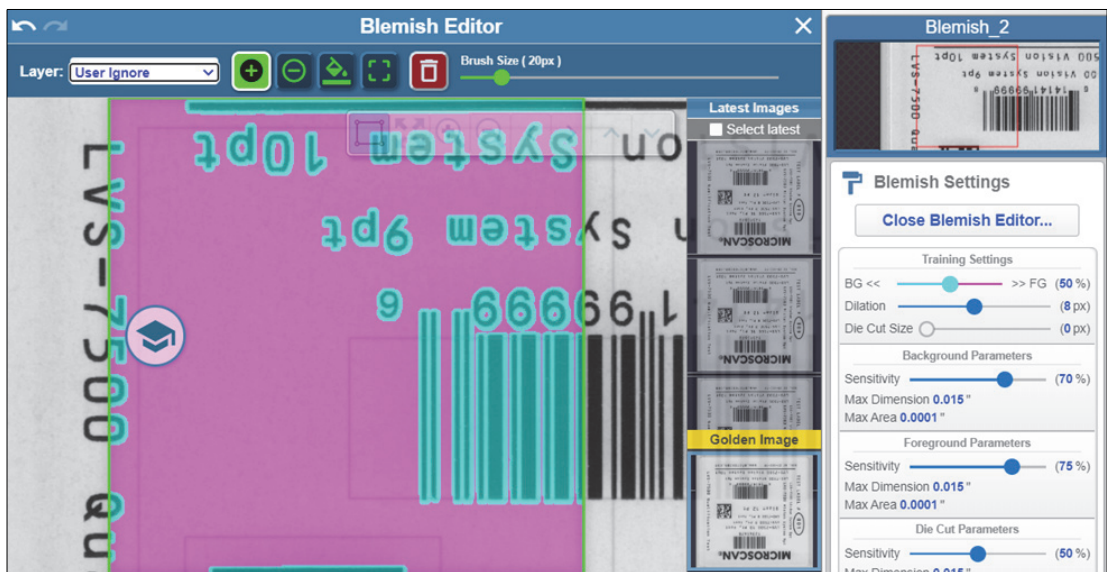

9-10-4 Layers

By the default the **User Ignore** layer will be selected, meaning all drawing operations will be applied to the user ignore layer. You can change the layer between **User Ignore** and **BG / FG Separation** using the dropdown at the left of the editor.

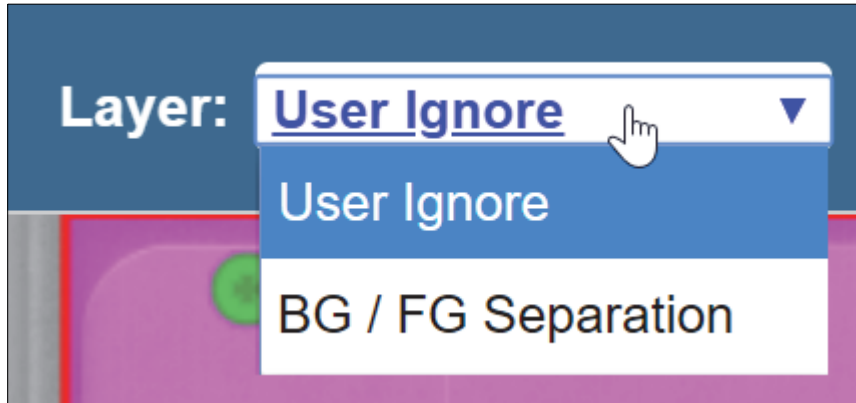

The User Ignore layer is green, and is for making areas of the region for the inspection to ignore. If you have variable data on the image (such as incrementing numbers), it's sometimes necessary to make sure the system ignores that area to avoid unnecessary alarms as the data changes label to label, which is what this layer is used for.

The BG / FG Separation layer is for defining which pixels are considered background, and which are considered foreground. The pink and light blue represent the foreground and background layers respectively. This means that if a label is inspected and a dark pixel (darker than a user-specified threshold) shows up in an area defined as background (the lighter areas), you will get a **Background Alarm**, and vice versa for foreground.

9-10-5 Tools

There are four tool types, with only the colors changing depending on the selected layer:

- **Draw:** This is used to draw brush style onto the selected layer. The size of the brush can be changed using the slider on the right of the edit panel.

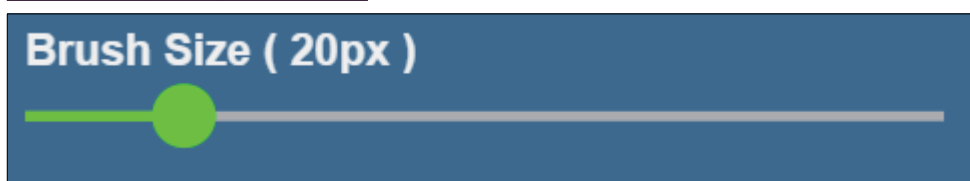

- **Erase:** This behaves the same as the draw tool but erases. Only applicable on the User Ignore layer.



- **Fill:** This tool will flood fill on the selected areas, filling with the color of the selected tool / layer:

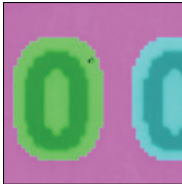

- **Area:** Click and drag across the region with this tool selected to fill in a rectangular area:

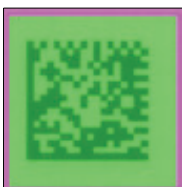
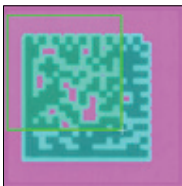

9-10-6 Clearing Layer

Click the **Clear** icon to clear the entire layer of user edits.



9-10-7 Undo / Redo

The **Undo / Redo** buttons are at the top left of the edit panel. They undo / redo user edits to the mask.



9-10-8 Blemish Parameters – Training Settings

The blemish parameters are displayed on the right panel of the **Edit** view.



The **Training Settings** alter the auto trained mask.

- The **BG << >> FG** slider changes the threshold for BG / FG pixels.
- **Dilation** changes the padding around foreground pixels.
- **Die Cut Size** alters the width of the outer die cut layer.

The image will live-update as you change these settings.

The other settings below Training Settings allow you to have more fine-grained control over what is considered a blemish during inspection.

The **Sensitivity** sliders adjust the system's allowable deviation in contrast (**0** accepts all, **100** accepts no variation). **Max Dimension / Max Area** adjust the tolerances of detected blemishes. Testing with different values is the best way to understand the effect.

9-11 Alarms / Outputs

Alarms take inspection results and turn them into outputs. Those outputs can be digital I/O as well as output events back to the UI. The V275 defines a fixed set of Alarms, and each alarm is typically associated with a particular region type or types. An alarm typically indicates a failure, but they can also indicate warnings and passes. Below is an example of an alarm on a 2D region appearing in the **Edit** view.

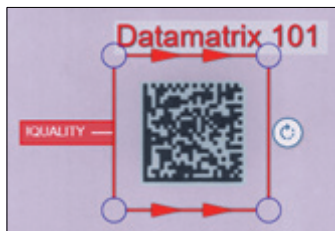

In the Edit view you can configure the I/Os of the device and how they will behave in response to different alarms. There are three kinds of alarms: **Passes**, **Warnings**, and **Failures**. Each output can be tied to a different alarm category as shown below. The output will be fired when an alarm occurs that is of its assigned category.

Outputs

<p>→ Stop Motion Latch</p>	Failures
<p>→ Green Light Pulse for 100 ms</p>	Passes
<p>→ Amber Light Pulse for 100 ms</p>	Warnings
<p>→ Red Light Pulse for 100 ms</p>	Failures

<p>→ Green Light Pulse for 100 ms</p>	<div style="border: 1px solid black; background-color: #f0f0f0;"> <p>Passes ▾</p> <p>Passes</p> <p>Warnings</p> <p>Failures</p> </div>
<p>→ Amber Light Pulse for 100 ms</p>	Warnings

In the example above, stop motion and the red light would be triggered by **Failure** alarms, the green light by **Pass** alarms, and amber by **Warning** alarms.

Note: The names of the outputs are configurable through the software's configuration file.

To change the **Pulse / Latch** settings, select the appropriate settings on the output box. When the output is set to **Latch**, this means the output will stay on until the alarms are cleared. When set to **Pulse**, the output will turn on for the specified amount of time, e.g. 100 ms as in the above image, and then turn off. **Stop Motion** must always be set to Latch.

9-12 Live Results

When editing the job in the **Edit** view, region results will be automatically generated and displayed within the view as you edit. A red region outline indicates a failed region and green outline indicates a passing region, and output data is displayed above the region if present.



To view advanced results data, click on the region grade in the **Regions** list.



9-13 Editing

9-13-1 Reviewing Read Errors

A quiet zone is non-printed or white space around each side of the barcode that provides tolerance while the device locates the barcode.



Another reason that the software can't read the barcode is that it might be reading in the wrong direction. You can see that the arrows indicate that this region is reading from left to right. However, this barcode is upside down, and so must be read from right to left, so we need to change the direction it will be read in by clicking the reverse direction icon. The software can now read the barcode image.



Another way you can tell if the barcode is being decoded or not is to look at the label to the left of the barcode image. When the barcode is being read in the incorrect direction, the image looks like the example below.

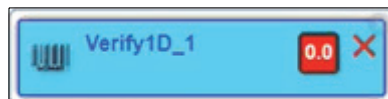

Once the barcode read direction is changed, the image changes and you can see it read a value on the barcode image.



Also, once the image is reduced to its normal size, you can see that the **Message** to the left of the selected region now says **!Quality**. This is a warning message indicating the quality of the symbol isn't acceptable.



If this region were set up correctly, the region would have turned green. Because it didn't, click on the **Region** score.

0.0

1 Verify1D_1 - UPC-A	
Overall Grade	0.0 (F)
Decodability	4.0 (A)
Decode	0.0 (F)
Symbol Contrast	4.0 (A)
Edge Contrast	4.0 (A)
Modulation	4.0 (A)
Defects	4.0 (A)
Min Reflectance	4.0 (A)
Rmin	12%
Rmax	83%
Aperture	6mils
Quiet Zone Left	0% X
Quiet Zone Right	100% ✓
Xdim	13.3mils

You can review the various quality checks V275 Software performs on the barcode, and see which ones contain errors.

A screenshot of the same barcode inspection software interface as above. A blue callout box with white text points to the 'Quiet Zone Left' row in the table. The text in the callout box reads: 'The reason for the problem is not enough quiet zone on one side of the barcode.' The 'Quiet Zone Left' row in the table shows '0%' with a red 'X' icon. The 'Quiet Zone Right' row shows '100%' with a green checkmark icon. The barcode image in the background is the same as in the previous image, but the '!QUALITY' message is not visible.

9

By increasing the quiet zone, the region turns green and the Region reports it as having a perfect 4.0 readability score.

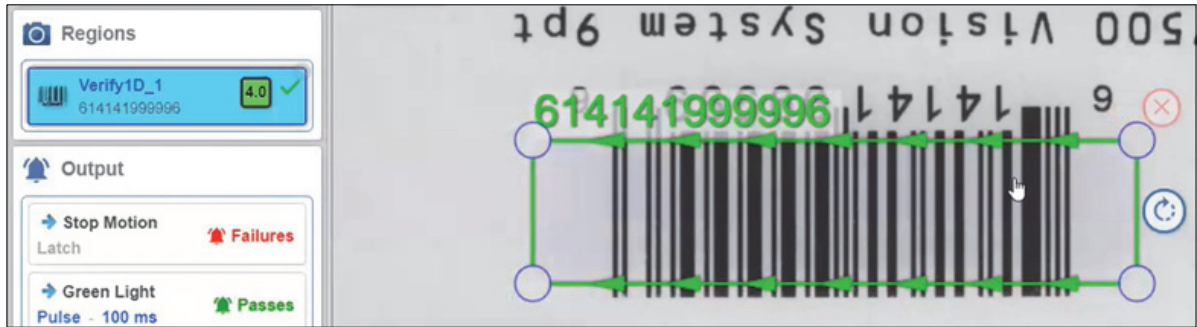

The configuration panel for 'Verify1D_1' includes the following sections and callouts:

- Symbology:** Type: UPC. Callout: "You can select another symbology if you want to change it by using the drop-down list."
- Grading:** Fail under (2.0) and Warn under (2.5) sliders. Callout: "You can fine-tune the grading to indicate when to show failure and warning errors by using the sliders."
- Data Matching:** Mode: Standard. Callout: "Use this section to configure Data Matching."
- Quality Specification:** Spec: ISO/IEC 15415/15416 (Default). Callout: "The specification used for validation."

Note: You can use the left pane to fine-tune additional information and error reporting for the symbology used. Suggested failure and warning values are Fail under 1.5 and Warn under 2.5 so your operator has time to take action before an actual failure can occur.

10

Run Mode

This section describes the software's runtime interface.

10-1	Run Mode	10-2
10-1-1	Panel Definitions	10-2
10-1-2	Failed Label Handling	10-3

10-1 Run Mode

Inspections are performed and results are monitored in **Run** mode. Generated alarms are displayed to the user for action and the appropriate I/Os will be triggered. After the job is set up, to transition to Run mode, click the Run chevron.



Note: Selecting **Run** will enable the printer to begin printing but does not control what is spooled to the printer. The user or application needs to ensure the proper print job is sent to the printer for inspection. Below is an example of a typical run view, with each section of the view explained in detail.

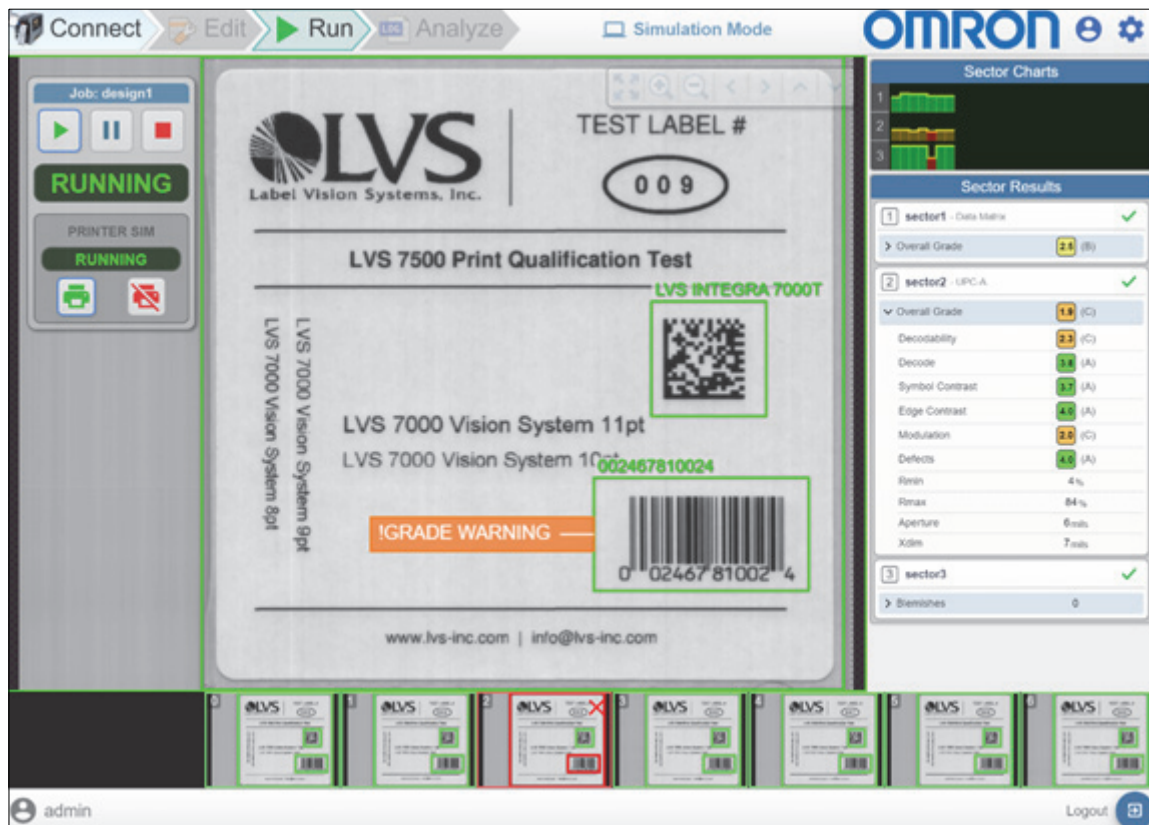

10-1-1 Panel Definitions

Panels

- **Run Control Panel:** The panel at the top left of the run view is used to control the state of the inspection and to determine the current state.
 - Click **Pause** to stop any inspection or printing that is occurring until the job is resumed.
 - Resume the job by clicking the **Play** button.
 - Click the **Stop** button to cancel the job.
- Note:** The **printer sim** area only appears when in **Simulation Mode**, and controls the feeding of simulation images from the software.

- **Region Charts:** Each column in the Region Charts box represents the inspection results history graph of a region. Green represents pass, orange for warning, and red for fail.
- **Region Results:** The Region Results panel lists detailed results data for each region. These results can be expanded/collapsed. When in a Paused state, extra region result data will be accessible from this panel in the form of dialogs.
- **Run Filmstrip:** The run filmstrip at the bottom shows a thumbnail history of previous inspections. Hovering over a thumbnail on the filmstrip causes the Run View to display the results/image for that particular label (instead of the latest).

10-1-2 Failed Label Handling

Error View: When an alarm(s) occurs, stop motion is triggered and the UI will move into error handling mode. A panel will appear on the right that will list all of the errors that have occurred and will then prompt user actions. See the example below.

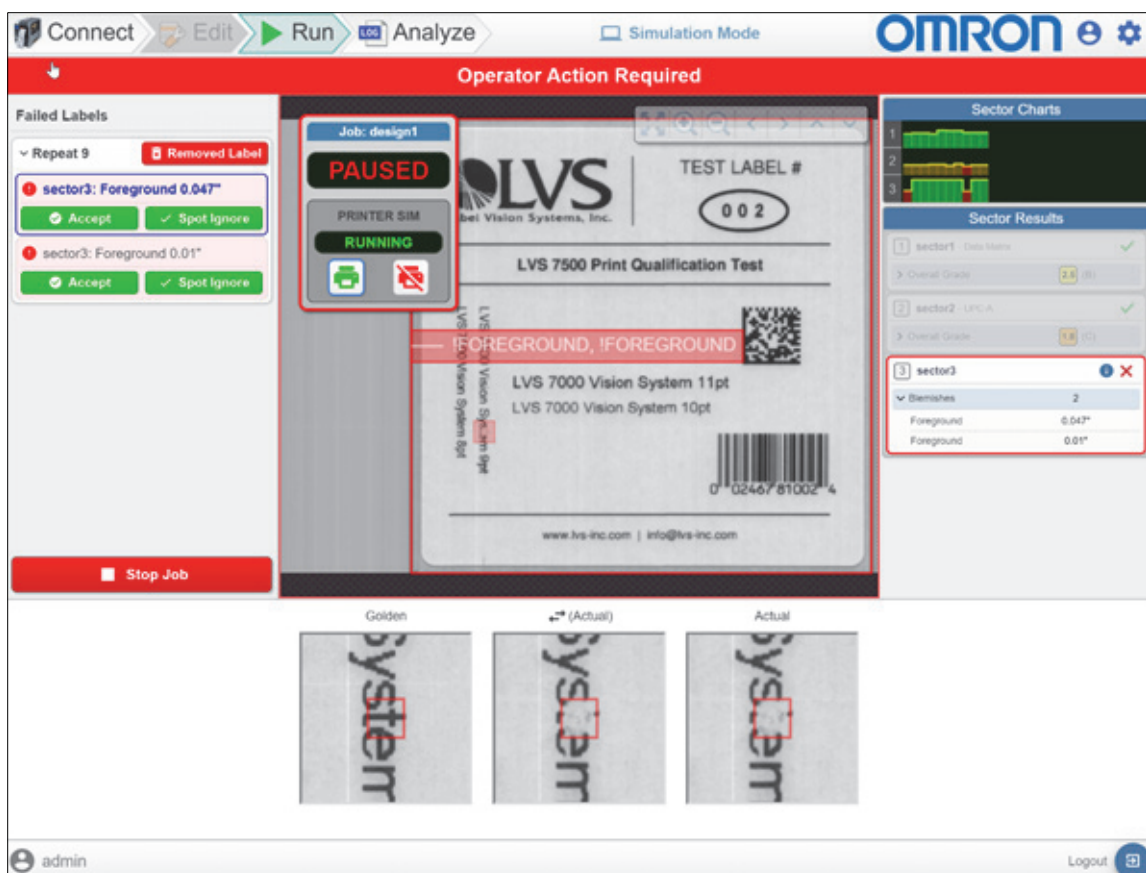

Selecting an error from the left panel will generate a panel on the bottom that displays advanced error data, e.g., blemish artifacts (above example).

Each error will have options displayed for handling that error, and when all errors have been dealt with, you will be able to continue the job. The options for handling errors are as follows:

- **Accept:** This will mark the error as accepted in the inspection logs. This is used when the flagged defect is deemed acceptable by the operator.
- **Spot Ignore:** For blemish errors selecting this option will add an area around this blemish to the “ignore” layer of the blemish mask, preventing this error from showing up in the future as it will be ignored. This option only appears for blemish errors.
- **Removed Label:** This option appears at the top of the error panel and is used when the user agrees that this label is bad and has removed this label from the web.

After all errors have been addressed, the user may continue the job. See the example below.

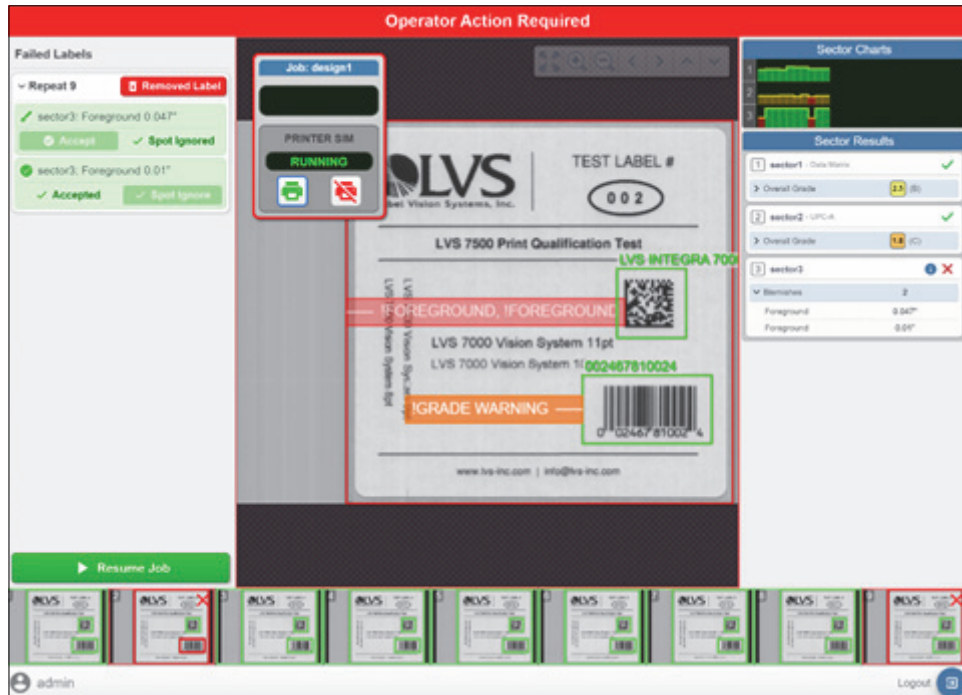

11

Analyze (Log Viewer)

This section describes the Log Viewer, which can be used to analyze the logs generated from each inspection run.

11-1	Run Ledger	11-2
11-1-1	Individual Run Logs	11-2
11-1-2	Viewing Results	11-3
11-1-3	Data Exporting: PDF Reports	11-4
11-1-4	Data Exporting: Raw Data Export	11-5

11-1 Run Ledger

Click the **Analyze** button to access the **Log Viewer**.



The initial page of the Log Viewer shows the list of run logs and selected data related to each.

Log Name	Time	Cycles	Failures	Operator	Computer	Job
RunLog_Scanner000000000...	2019-11-...	3	0	admin	MSRN0360	design1
RunLog_Scanner000000000...	2019-11-...	2	2	admin	MSRN0360	design1
RunLog_Scanner000000000...	2019-11-...	9	9	admin	MSRN0360	design1
RunLog_Scanner000000000...	2019-11-...	16	3	admin	MSRN0360	design1
RunLog_Scanner000000000...	2019-11-...	5	5	admin	MSRN0360	design1
RunLog_Scanner000000000...	2019-11-...	5	5	admin	MSRN0360	design1

11-1-1 Individual Run Logs

Clicking on any of the run titles will open up the full log for that run. Below is an example of a run log. Clicking the arrow at the top left will return you to the **Run Ledger**.

Repeat	OMRON	Left128	Right128	RightUPCA	LeftUPCA	LeftDatamatrix	RightDatamatrix	LeftOCV	RightOCV
1	OK	24109-90 OK	24109-90 OK	61414199 OK	61414199 OK	Axial Non ... OK	Axial Non ... OK	LVS275 OK	LVS275 OK
2	1 NO_READ	NO_READ	NO_READ	NO_READ	NO_READ	NO_READ	NO_READ	Mismatch (1)	Mismatch (1)
3	OK	24109-90 OK	24109-90 OK	61414199 OK	61414199 OK	Axial Non ... OK	Axial Non ... OK	LVS275 OK	LVS275 OK
4	OK	24109-90 OK	24109-90 OK	61414199 OK	61414199 OK	Axial Non ... OK	Axial Non ... OK	LVS275 OK	LVS275 OK
5	1 NO_READ	NO_READ	Quality (1)	61414199 OK	61414199 OK	Axial Non ... Quality (1)	Axial Non ...	Mismatch (1), Quality (1)	LVS275

11-1-2 Viewing Results

Clicking on a region that passed (green box) displays the quality grades from that region.

<p>1 sector1 - code128</p> <p>Overall Grade 4.0 (A)</p> <p>Decodability 4.0 (A)</p> <p>Decode 4.0 (A)</p> <p>Symbol Contrast 4.0 (A)</p> <p>Edge Contrast 4.0 (A)</p> <p>Modulation 4.0 (A)</p> <p>Defects 4.0 (A)</p> <p style="text-align: center;">1D</p>	<p>1 sector1 - Data Matrix</p> <p>Overall Grade 4.0 (A)</p> <p>Decode 4.0 (A)</p> <p>Symbol Contrast 4.0 (A)</p> <p>Modulation 4.0 (A)</p> <p>Axial Non-Uniformity 4.0 (A)</p> <p>Grid Non-Uniformity 4.0 (A)</p> <p>Unused Error Correction 4.0 (A)</p> <p>Fixed Pattern Damage 4.0 (A)</p> <p style="text-align: center;">2D</p>	<p>1 sector1 - pdf417</p> <p>Overall Grade 4.0 (A)</p> <p>Symbol Contrast 4.0 (A)</p> <p>Unused Error Correction 4.0 (A)</p> <p>CW Yield 4.0 (A)</p> <p>CW Print Quality 4.0 (A)</p> <p style="text-align: center;">PDF417 / MicroPDF417</p>
---	---	---

Clicking on a failed region shows the error display. There are three types of error displays: Blemish, OCR/OCV, and 1D/2D. The regular error display shows an image of the region that failed along with its quality grades.

sector1 - verify1D

1 sector1 - ean13

Overall Grade 1.1 (D)

Decodability 1.1 (D)

Decode 4.0 (A)

Symbol Contrast 4.0 (A)

Edge Contrast 4.0 (A)

Modulation 4.0 (A)

Defects 4.0 (A)

This is the blemish error display:

Blemish

Golden

+7 (Actual)

Actual

The three images on the top show the area that the blemish occurred, but the left is extracted from the golden image (what it should look like) and the right is the actual error. The middle toggles between the two to make it as clear what the difference is. The bottom is the golden image with error region highlighted. If there are multiple errors for one region you can toggle between them using the arrows at the top left / right.

This is the OCR/OCV error display, which shows detailed character data:

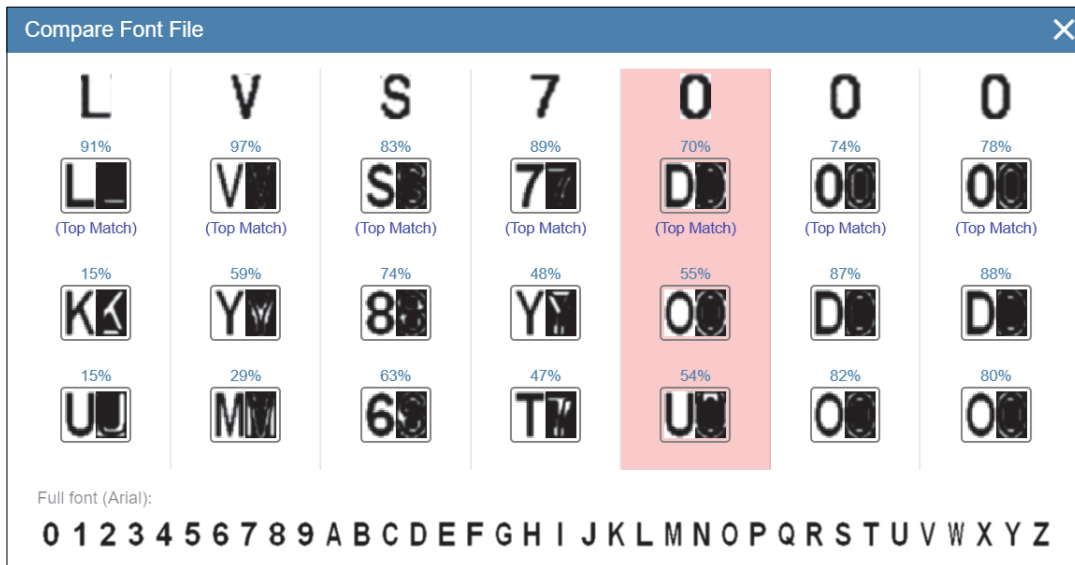

11-1-3 Data Exporting: PDF Reports

PDF reports can be generated and downloaded by clicking on the download icon found in the Analyze view, and select the PDF option. They currently appear in three places: Next to the log name in the Run Ledger (downloads Run Summary for that row), next to the repeat number in a Run Log (downloads a Repeat Report for that row), and at the top right of a Run Log (downloads a Run Summary for the selected log).

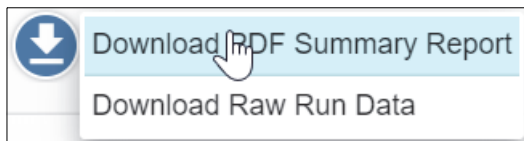

There are two types of PDF reports:

Repeat Report: Displays detailed region results for a single repeat inspection. There will be a repeat summary and a list of region results with result data and relevant images.

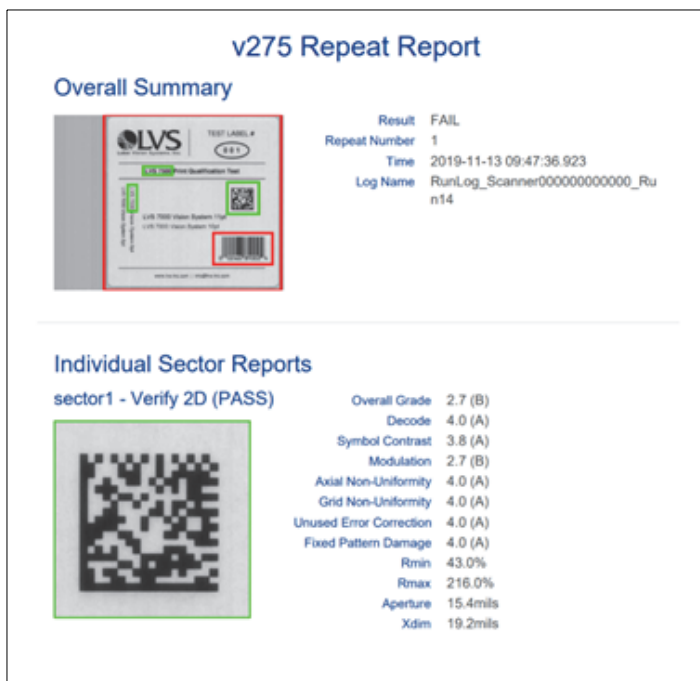

Run Report: Displays a summary of a full run. There will be an overall run summary at the top with basic run info, and then a list of region-specific summaries.

v275 Run Report

Overall Summary

Job Name	design1
Operator	admin
Start Time	2019-11-12 15:32:44
End Time	2019-11-12 15:33:21
Start Repeat	0
End Repeat	8
Repeats Inspected	9
Repeats Replaced	1
Repeats Failed	9

Individual Sector Summaries

sector1 - Verify 2D

Passed	9/9 (100%)
Overall	[4.0]:3 (33.3%), [4.0]:6 (66.7%)
Decoded Text	Datamatrix 100
Symbology	Data Matrix
Symbol Contrast	[4.0]:3 (33.3%), [4.0]:6 (66.7%)
Modulation	[4.0]:9 (100%)
Axial Non-Uniformity	[4.0]:9 (100%)
Grid Non-Uniformity	[4.0]:9 (100%)
Unused Error Correction	[4.0]:9 (100%)
Fixed Pattern Damage	[4.0]:9 (100%)
Xdim	13.2 to 13.3; Average was 13.3

11-1-4 Data Exporting: Raw Data Export

For users who require access to all data (beyond what our PDF reports provide) there is also an option to download the raw data from a run or a repeat. To do this, click the download button and select the raw data option.



This will create a .zip that contains all JSON result data, the golden image, region images, and all error artifact images.

Downloads > RunLog_Scanner000000000000_Run31-result-data (4) >

Name	Date modified	Type	Size
artifacts	11/25/2019 11:03...	File folder	
sector-images	11/25/2019 11:03...	File folder	
golden-image.png	11/25/2019 11:03...	PNG File	2,984 KB
run-data.json	11/25/2019 11:03...	JSON File	67 KB



Audit Trail

This section describes the Audit Trail Database and Audit Trail Viewer.

12-1 Audit Trail Database	12-2
--	-------------

12-1 Audit Trail Database

All significant actions taken by the user are logged in the **Audit Trail Database**. The contents of the Audit Trail can be viewed by going to the gear menu in the upper-right corner of the UI and selecting **Show Audit Trail...**

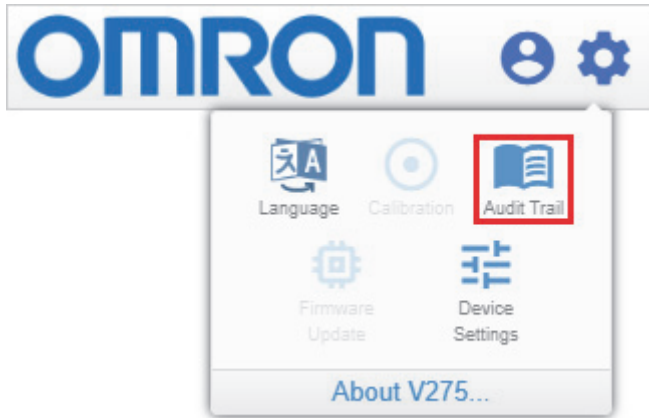

This brings up the **Audit Trail Viewer**:

Audit Trail Viewer			
Date	Time	User	Action
2019-07-31	13:47:50	admin	Job Load started for "design/gs1_test"
2019-07-31	13:47:50	admin	New Job created. Saved as "design/gs1_test"
2019-07-31	13:46:11	admin	Logged in with full control
2019-07-31	12:11:37	admin	User session timed out and closed
2019-07-31	12:00:39	admin	Attempted to enter run mode, but Job is not ready to run
2019-07-31	12:00:21	admin	Job "design/ocr_test" loaded successfully
2019-07-31	12:00:21	admin	Job Load started for "design/ocr_test"
2019-07-31	12:00:04	admin	Job "design/ocr demo" loaded successfully
2019-07-31	12:00:03	admin	Job Load started for "design/ocr demo"
2019-07-31	11:59:58	admin	Logged in with full control
2019-07-31	11:59:42	<none>	Loaded 1 user accounts
2019-07-31	11:59:42	<none>	Loading local user accounts

[EXPORT TO PDF](#) [CLEAR AUDIT FILE](#) [CLOSE](#)

The Audit Trail lists such actions as a user logging in or out, jobs being loaded, regions being modified, jobs being started or stopped, user accounts being modified, etc. The date and time of each action is listed on the left, along with the name of the user who performed it. A description of the action is also listed on the left. The Audit Trail can be exported to a PDF by clicking the **Export to PDF** button at the bottom of the dialog. If the current user is an administrator, you may also clear the audit file by clicking the **Clear Audit File** button. Only an administrator can clear the Audit Trail.



System Specifications



A-1 Ratings and Specifications A-2

A-1 Ratings and Specifications

V275 Print Inspection Engine	
Minimum 1D Code Size	6.6 mil / .168 mm x dimension
1D Code Orientation	Ladder or picket fence
Minimum 2D Code Size	10 mil / .254 mm cell size
ISO/IEC Standards	ISO/IEC 15416 (1D grading); ISO/IEC 15415 (2D grading); ISO/IEC 15426-1 (1D verification); ISO/IEC 15426-2 (2D verification)
Symbologies Supported	Aztec, Codabar, Code 128, Code 39, Code 93, Data Matrix, DataBar Expanded, EAN-13, EAN-13 (2-digit supplemental), Stacked EAN-13 (5-digit supplemental), EAN-8, GS1-128, GS1 DataBar Limited, GS1 DataBar, GS1 DataBar-14, GS1 Data Matrix, Interleaved 2 of 5, Micro QR Code, PDF417, QR Code, UPC-A, UPC-A (2-digit supplemental), UPC-A (5-digit supplemental), UPC-E, UPC-E (2-digit supplemental), UPC-E (5-digit supplemental), All applicable GS1 composite components
Minimum Font Size for OCR/OCV	5 pt.
OCR/OCV Fonts Supported	Mono-spaced, Latin-based fonts, OCR-B upper and lower case, OCR-A lower case
Minimum Blemish Detected	5 mil / .126 mm
Maximum Inspection Speed	Zebra ZT610 300 dpi: 12" / 305 mm per second Zebra ZT610 600 dpi: 6" / 152 mm per second Zebra ZT620 300 dpi: 8" / 203 mm per second
Maximum Inspection Width	Zebra ZT610: 4.09" / 104 mm Zebra ZT620: 6.6" / 168 mm
Maximum Web Width	Zebra ZT610: 4.5" / 114 mm Zebra ZT620: 7.1" / 180 mm
Minimum Inspection Width	0.98" / 25 mm
Maximum Label Length	12" / 305 mm
Minimum Label Length	0.8" / 20 mm
Maximum Media Thickness	0.011" / 0.28 mm
Minimum Media Thickness	0.002" / 0.05 mm
Printer Compatibility	Zebra ZT610 (4", 300 dpi and 600 dpi) Zebra ZT620 (6", 300 dpi)
Print Methods	Direct Thermal Thermal Transfer
Print Modes	Rewind Dispenser / Peel and Present Tear-Off (Limited to certain label types. Contact Omron for details.)
Label Types	Most common labels types supported. Contact Omron for information about transparent labels, shiny labels, colored labels, colored ink, unusually thick or unusually thin label stock.
Communications / Power	802.3af Power over Ethernet (PoE)
V275 Software Requirements	
PC	Quad-Core 2.6 GHz Processor 8 GB RAM 500 GB Storage Dedicated Gigabit Ethernet NIC for interface with V275 Print Inspection Engine, ideally PoE Windows® 7 or Windows® 10, 64-bit
Environmental	
Operating Temperature	32° - 104° F / 0° - 40° C
Storage Temperature	-4° - 140° F / -20° - 60° C
Operating Humidity	30% - 75% RH, non-condensing
Storage Humidity	30% - 90% RH, non-condensing
Regulatory	
EMC	FCC 47 CFR Part 15 Class B ICES-003 Emissions EN 55032 Class B Immunity EN 55024 / EN 55035
Safety	IEC 60950-1, IEC 62471, IEC 62368-1
Agency Approvals	cULus, CE marking

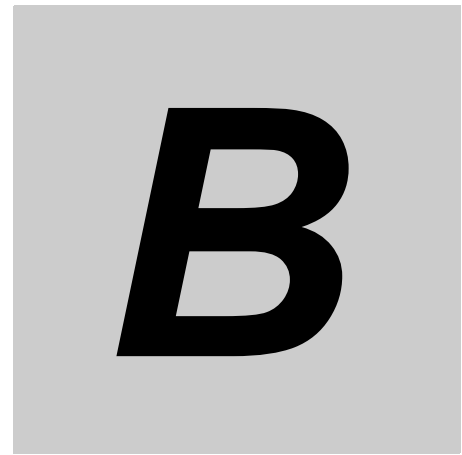



Ordering Information







B-1	Products	B-2
B-2	Accessories	B-3
B-3	Service and Repair Kits	B-5

B-1 Products

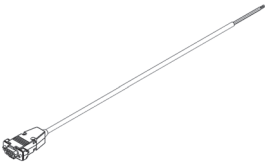
Appearance	Description	Part Number
	V275 print inspection engine, integrated into a 300 dpi resolution Zebra ZT610 printer. Print and verify labels up to 4.1" wide at speeds up to 12 inches per second.	V275-P46Z61030-CC
	Same as above, with peel and present capability.	V275-P46Z6103P-CC
	V275 print inspection engine, integrated into a 600 dpi resolution Zebra ZT610 printer. Print and verify labels up to 4.1" wide at speeds up to 6 inches per second.	V275-P46Z61060-CC
	Same as above, with peel and present capability.	V275-P46Z6106P-CC
	V275 print inspection engine, integrated into a 300 dpi resolution Zebra ZT620 printer. Print and verify labels up to 6.6" wide at speeds up to 8 inches per second.	V275-P86Z62030-CC
	Same as above, with peel and present capability.	V275-P86Z6203P-CC

B-2 Accessories

Appearance	Description	Part Number
	<p>Light tower for use with the V275. Includes light tower and cable for connecting with Zebra printer.</p>	<p>V275-ALRYGZZT</p>
	<p>Cable for connecting the V275 Zebra printer with a customer-supplied light tower. Cable is 2m long and has flying leads to allow adaptation to almost any light tower. Customer is responsible for connection to the light tower.</p>	<p>V275-ALCBL0ZT</p>
	<p>Replacement EAN/UPS Conformance Calibration Standard Test Card for V275 in Zebra ZT610 printer, dated.</p>	<p>V275-ACEAN028</p>
	<p>Replacement EAN/UPS Conformance Calibration Standard Test Card for V275 in Zebra ZT610 printer, undated.</p>	<p>V275-ACEAN028-01</p>
	<p>Replacement EAN/UPS Conformance Calibration Standard Test Card for V275 in Zebra ZT620 printer, dated.</p>	<p>V275-ACEAN029</p>
	<p>Replacement EAN/UPS Conformance Calibration Standard Test Card for V275 in Zebra ZT620 printer, undated.</p>	<p>V275-ACEAN029-01</p>

B

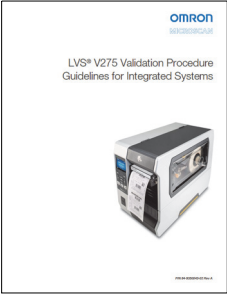
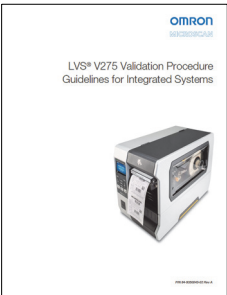
Appearance	Description	Part Number
	<p>IQ/OQ/PQ Procedure for V275 system with 300 dpi printer</p>	<p>V275-APIQQ03-01</p>
	<p>IQ/OQ/PQ Procedure for V275 system with 600 dpi printer</p>	<p>V275-APIQQ06-01</p>

B-3 Service and Repair Kits

Service and repair kits are intended for use by qualified personnel for service and repair activities only. These kits should not be used for field repairs by non-technical customers.

Appearance	Description	Part Number
	Replacement imaging device kit for Zebra ZT610-based V275 systems.	V275-RRH04ZEB
	Replacement imaging device kit for Zebra ZT620-based V275 systems.	V275-RRH06ZEB
	PCB replacement kit for Zebra-based V275 systems.	V275-RBS00ZEB
	Encoder replacement kit for Zebra-based V275 systems.	V275-RENC0ZEB
	Peel and present sensor replacement kit for Zebra-based V275 systems.	V275-RPPS0ZEB
	Rear panel replacement kit for Zebra-based V275 systems. Includes internal cabling.	V275-RRPC0ZEB

B

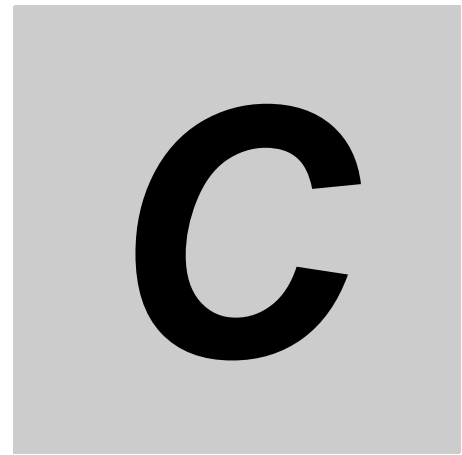

Preventive Maintenance

C

C-1	Preventive Maintenance	C-2
C-1-1	Sensor Instructions	C-2
C-1-2	Calibration Card Instructions	C-2
C-1-3	Recalibration Instructions	C-2

C-1 Preventive Maintenance

C-1-1 Sensor Instructions

Maintaining a clean sensor is critical to the proper functioning of your LVS V275 Print Inspection System. Smudges, debris, dust, lint, label glue, and other foreign matter can find its way onto the sensor lens. These things will all be interpreted by the V275 Print Inspection System as defects in the label and will cause the V275 to evaluate the labels improperly. Weekly cleaning of the sensor is recommended to maintain optimum performance.

To maintain a clean and clear sensor, spray a soft, lint-free, non-abrasive towel or cloth with a commercially available household glass cleaner, such as Windex[®], Glassex[®], VISS[®], or Mr. Muscle[®], and gently clean the outside of the sensor glass.

DO NOT directly spray the sensor glass with glass cleaner. Always spray a towel or cloth with glass cleaner and then gently wipe the sensor glass.

DO NOT use an industrial-strength glass cleaner.

C-1-2 Calibration Card Instructions

Omron recommends regular calibration of your V275 Print Inspection System. Always use a clean, undamaged calibration card. Omron recommends replacing the Calibrated Conformance Standard Test Card every two years, or whenever it becomes damaged or dirty, whichever comes first.

If you have questions or concerns about the performance of the V275 Print Inspection System, please contact your Omron representative.

C-1-3 Recalibration Instructions

Omron recommends recalibrating the V275 Print Inspection System monthly. Be sure the sensor is clean and wait at least 5 minutes after turning on the system for the hardware to warm up before calibration.



Importing LVS-7510 Templates



D-1	Importing LVS-7510 Templates	D-2
D-1-1	Copy LVS-7510 Template Folder(s)	D-2
D-1-2	Copy Legacy Template Folders to the V275 Import Folder	D-2
D-1-3	Restart the V275 Service	D-2
D-1-4	Copy the Imported Template from the Repository to Your Node	D-4
D-1-5	Open and Configure the Imported Template	D-4
D-1-6	What Cannot be Imported from a Legacy Template	D-5

D-1 Importing LVS-7510 Templates

Templates created for LVS-7510 Print Quality Inspection products are not compatible with the V275 System. The V275 has a higher-resolution sensor, defines inspection regions differently and uses a different file format to manage and store templates. However, the V275 software does have the ability to import LVS-7510 templates. The import process will not result in fully functional V275 templates, but will create V275 templates that require only minimal manual adjustment to run successfully.

The following steps explain the import process.

D-1-1 Copy LVS-7510 Template Folder(s)

- 1** On the PC that contains your LVS-7510 templates, go to your \LVSDData\LV57500\Design\Templates folder, and select the templates that you want to import to the V275.
- 2** Copy as many templates as you like, but make sure you copy the entire folder for each template, not just its INI file.

For this example, we show the import of a single legacy template, but it is also possible to import multiple templates at the same time.

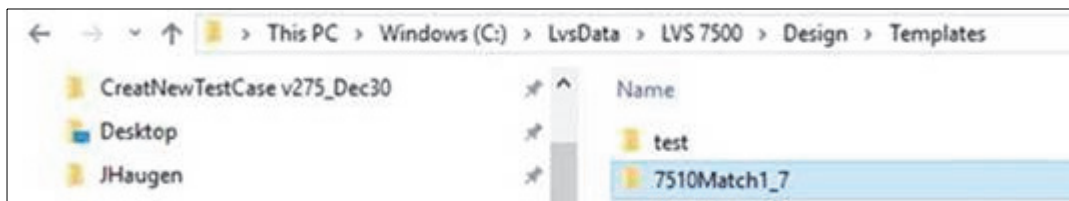

Note: You cannot import a legacy archive file or a zipped file. The import feature only works with unzipped template folders.

D-1-2 Copy Legacy Template Folders to the V275 Import Folder

On your V275 PC, copy all of the 75xx template folders that you want to import to the \V275\data\Import folder.

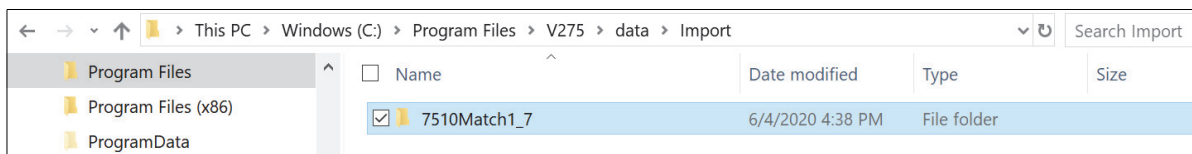

D-1-3 Restart the V275 Service

When V275 Software starts up, it always checks its Import folder for legacy templates, automatically converts them to the V275 format, and then saves them to the JobRepository.

To force the V275 System to import your jobs, execute the following steps to restart the V275 service or reboot the server PC:

- 1** Open Task Manager;
- 2** Select the **Services** tab, and find **V275Service** in the list;

3 Right-click and select **Restart**.

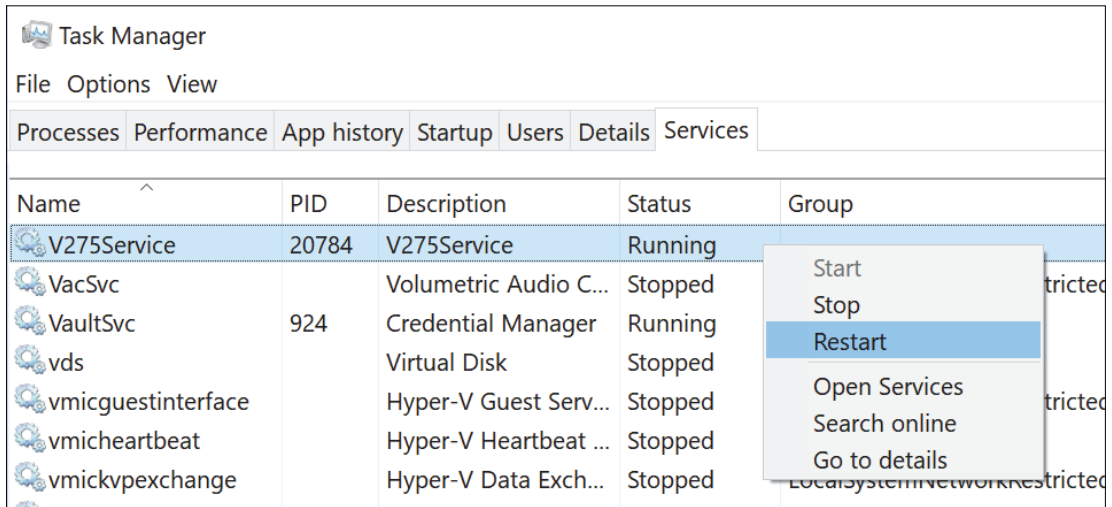

After the restart is complete, you should see the imported job in the \\V275\data\JobRepository folder.

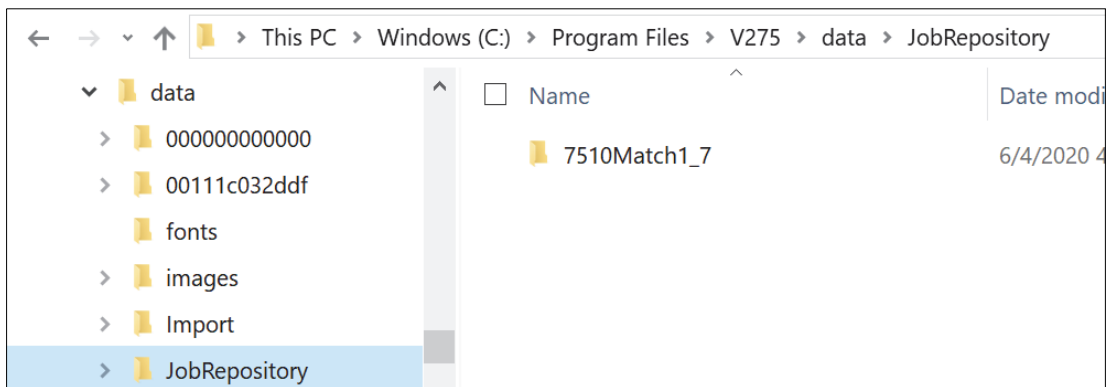

Once a template has been imported, V275 renames its folder to start with the text "IMPORTED_". This prevents the legacy template from being imported repeatedly if the user forgets to remove it from the Import folder.

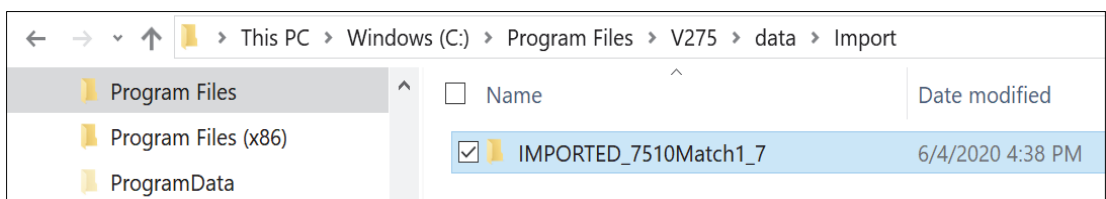

D-1-4 Copy the Imported Template from the Repository to Your Node

- 1 In the V275 User Interface, login to your printer node, and then open the **Repository Templates** list, at the top of the right panel.



You should see your imported template listed there.

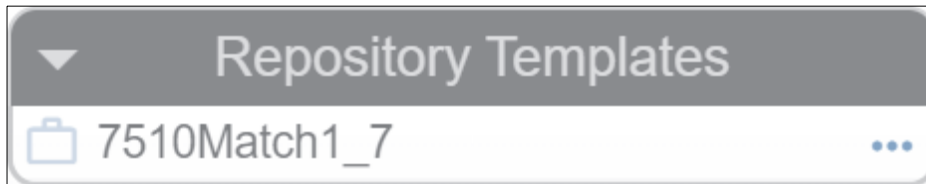

- 2 Click on the '...' icon on the right side of the template name to open the options menu, and then choose **Copy Template to Device** to copy your imported template from the Repository to your printer node's template folder.

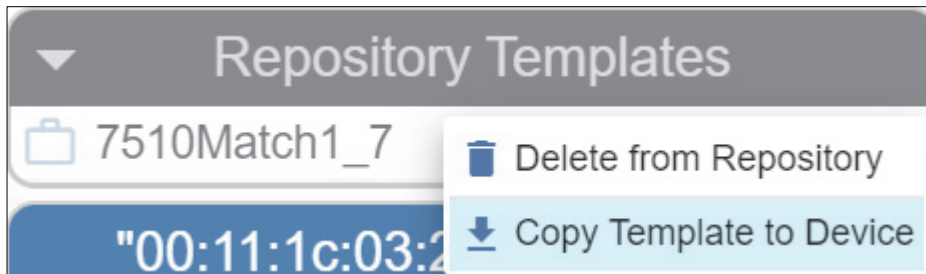

D-1-5 Open and Configure the Imported Template

Your imported template should now show up in the list of templates for your printer.

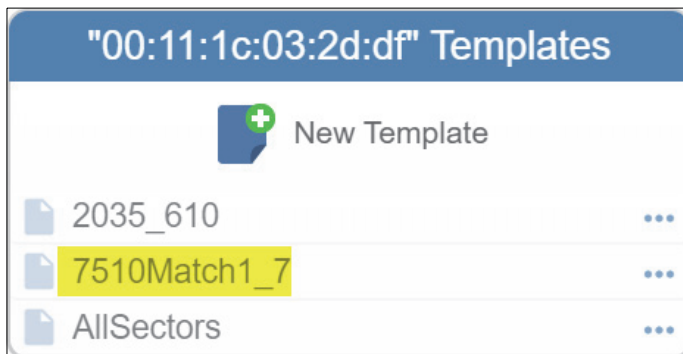

- 1 Click on the template name to load the imported template.
- 2 You can use the **Sync Setup** screen to set up your label job using your imported template.

D-1-6 What Cannot be Imported from a Legacy Template

When importing a legacy template, all the regions, and settings for those regions, as well as their ROI sizes and positions, are imported. If the template was created at a lower resolution, the V275 Software attempts to scale up the ROI sizes and locations to match the image size of the V275. Some features cannot be imported however, and will need to be setup again. Those features are as follows.

Image Synchronization

The V275 uses a different algorithm for locating labels, and this new approach is not compatible with the older approach used by the 75xx. For this reason, the sync information in a legacy template cannot be imported.

You will always need to re-train the sync the first time you load an imported template.

Custom OCR/OCV Font Files

If you created custom fonts for your legacy 75xx templates/jobs, these font files will need to be manually copied over to the V275 PC. Custom fonts don't live within a template folder, so they cannot be imported. If an imported template has OCR or OCV regions, and one or more of those regions are configured to use a font that is not found on the V275 system, then that OCR/OCV tool will be reset to use the default font (Arial).

You should copy any custom fonts from the legacy system over to your V275 system first, before importing the templates.

Custom Font Location

Copy your custom fonts to the **V275\data\fonts** folder.

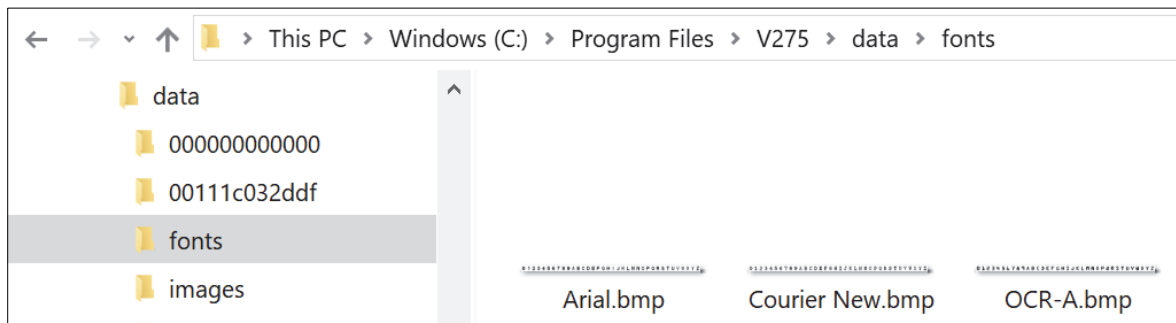

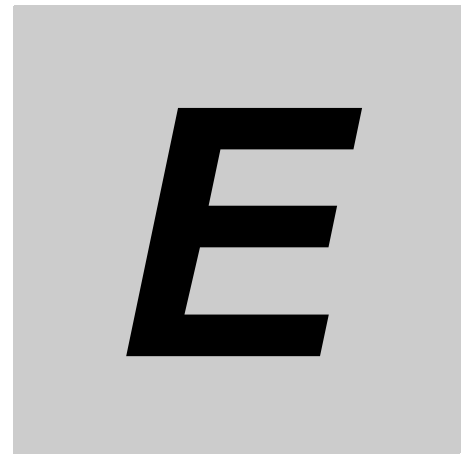

V275 Service Viewer

E

E-1	Purpose of the V275 Service Viewer	E-2
E-2	Startup	E-3
E-3	V275 Service Window	E-4
E-3-1	V275 Service Status Area	E-4

E-1 Purpose of the V275 Service Viewer

The V275 Service Viewer is a Windows tray application that provides feedback on the state of the V275 Service executables. Because the V275 runtime is installed as a Windows Service, it has no UI. This means that the user has nothing to provide diagnostic feedback when something goes wrong. The Tray Application is designed to communicate with the V275 System Server and Node processes in order to provide this diagnostic assistance.

E-2 Startup

The tray app should be installed to start when Windows starts up. It needs to know where the **V275.exe** is installed. This can be supplied as a command line argument:

-v275image=c:/dev/watsondev/phase2/product/v275

Or, if the command line is not installed, it will check the registry for the installed location:

HKLM\Software\Omron\V275Service\DataDirectory

It needs this information so it can find the enumeration file, and know what nodes are expected to launch. Once launched, the app will run in the background, and install an icon in the Windows System Tray:

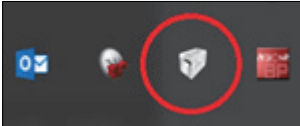

Right-clicking on the icon gives you the context menu:

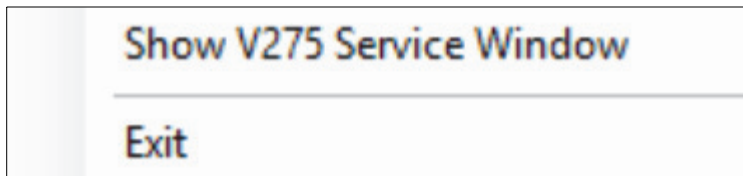

Show V275 Service Window will launch the main window. Selecting **Exit** will shut down the V275 Service Viewer. You are strongly advised not to click Exit.

E-3 V275 Service Window

This window gives the user an overview of the current state of the V275 Service and its associated V275 processes.

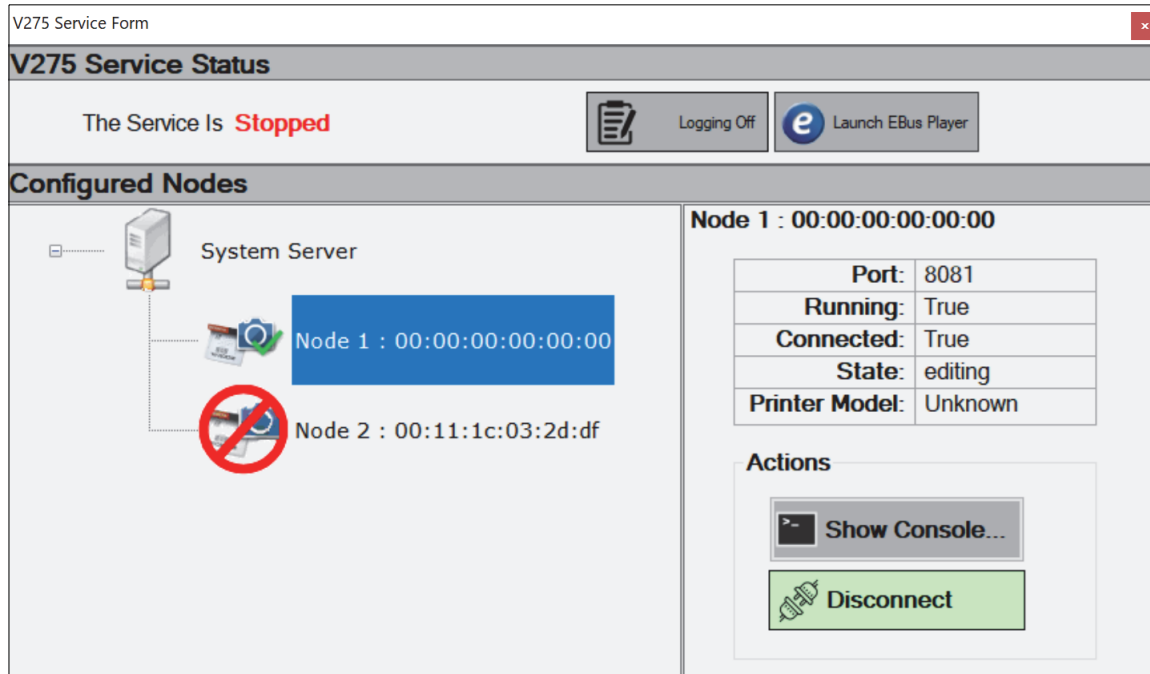

E-3-1 V275 Service Status Area

This section provides a constant status on the V275 Service (is it running, stopped, etc), as well as global options.

Status String

The Service Is **Running**

The Service Is **Stopped**

Lets the user know whether the service is running, stopped, or in some intermediate state. A background thread monitors the state of the service and regularly updates this string.

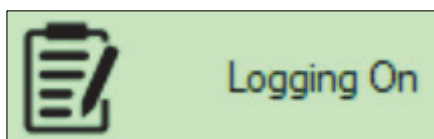

This toggle button is used to enable or disable logging in all of the V275 processes. If logging is already on, clicking this button will turn it off. If logging is not on, clicking this button will open a folder selection dialog. You simply select the folder where you want the logs to be written. A warning message will be displayed to alert the user that the logging setting will not take effect until the next time the service is started.

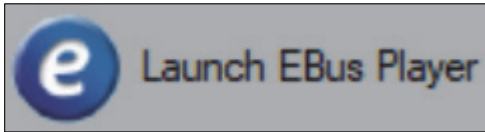

Launches the Ebus player application. This will allow users to see the devices that have been discovered on the network.

Configured Nodes Area

This section provides feedback on the state of the System Server and its child Node processes.

Tree View of Expected Processes

The tray app will read in the V275-enumeration.json file to see the list of nodes that were configured for this system. The tree view is then populated with an entry for the System Server process, and one entry for each enumerated node. A background thread will then monitor the state of the server and each node, and update their states regularly:

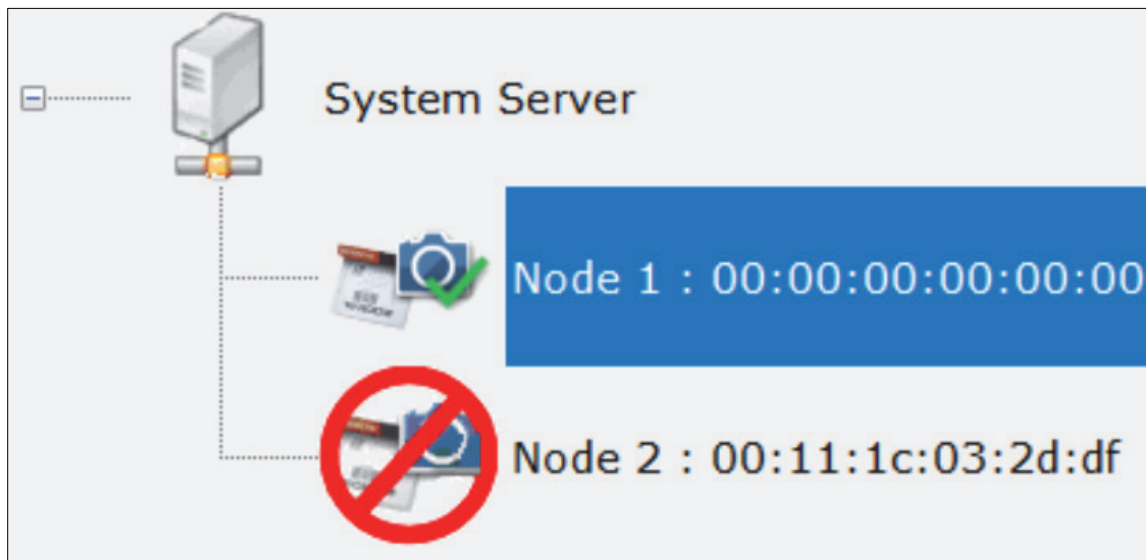

The icon for each node of the tree provides feedback on the current state of that process.

● System Server



Indicates that the Server process is up and running.



Indicates that the Server process is either not running, or can't be communicated with.

● **Nodes**



Indicates that the node process is running, and it is communicating with the scan head.



Indicates that the node process is running, but it is **not** communicating with the scan head.



Indicates that the node process is **not** running, or can't be communicated with.

Node Detail

Selecting any element in the tree view will populate the right panel with detailed information on your selection.

Node 1 : 00:00:00:00:00:00

Port:	8081
Running:	True
Connected:	True
State:	idle
Printer Model:	Unknown

Actions

▶ Show Console...

🔌 Disconnect

Actions Panel

The following actions can be performed on the selected node.

● Show Console

This will open a live console window for the node or server. This window will pull in up to 200 of the most recent status messages printed by the node. It will maintain a websocket connection to the node, and any subsequent status messages will also be displayed.

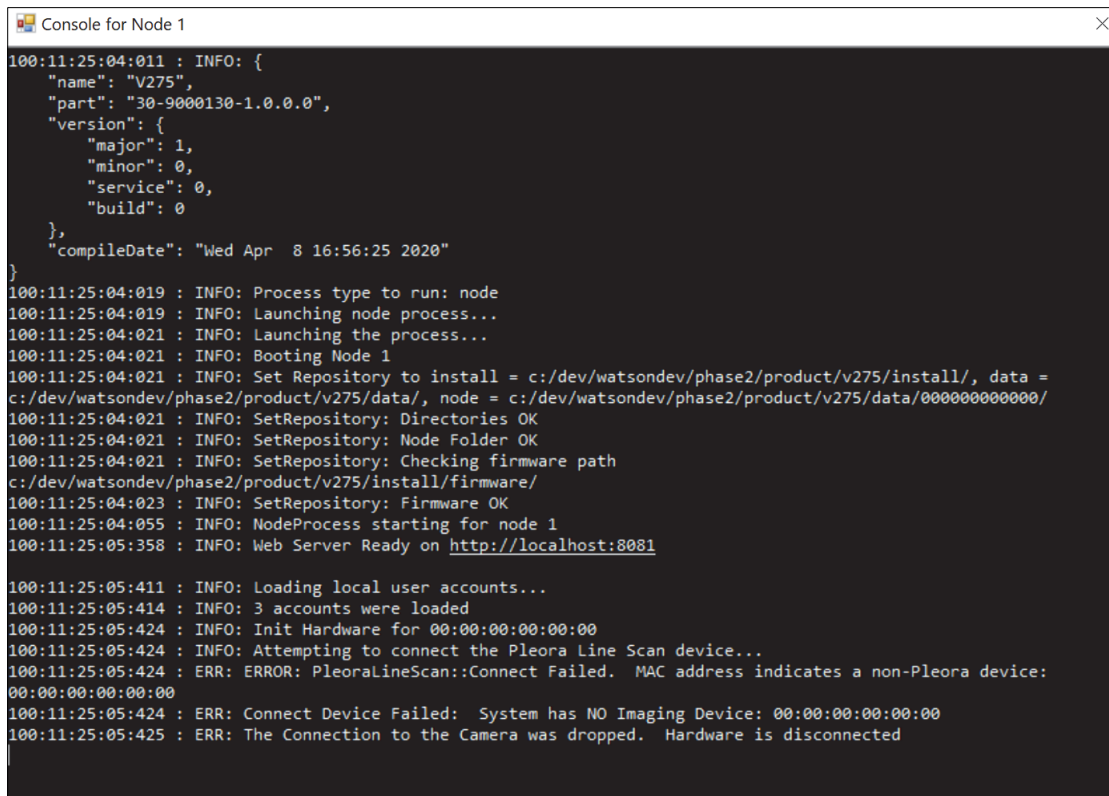

```

Console for Node 1
100:11:25:04:011 : INFO: {
  "name": "V275",
  "part": "30-9000130-1.0.0.0",
  "version": {
    "major": 1,
    "minor": 0,
    "service": 0,
    "build": 0
  },
  "compileDate": "Wed Apr  8 16:56:25 2020"
}
100:11:25:04:019 : INFO: Process type to run: node
100:11:25:04:019 : INFO: Launching node process...
100:11:25:04:021 : INFO: Launching the process...
100:11:25:04:021 : INFO: Booting Node 1
100:11:25:04:021 : INFO: Set Repository to install = c:/dev/watsondev/phase2/product/v275/install/, data =
c:/dev/watsondev/phase2/product/v275/data/, node = c:/dev/watsondev/phase2/product/v275/data/000000000000/
100:11:25:04:021 : INFO: SetRepository: Directories OK
100:11:25:04:021 : INFO: SetRepository: Node Folder OK
100:11:25:04:021 : INFO: SetRepository: Checking firmware path
c:/dev/watsondev/phase2/product/v275/install/firmware/
100:11:25:04:023 : INFO: SetRepository: Firmware OK
100:11:25:04:055 : INFO: NodeProcess starting for node 1
100:11:25:05:358 : INFO: Web Server Ready on http://localhost:8081

100:11:25:05:411 : INFO: Loading local user accounts...
100:11:25:05:414 : INFO: 3 accounts were loaded
100:11:25:05:424 : INFO: Init Hardware for 00:00:00:00:00:00
100:11:25:05:424 : INFO: Attempting to connect the Pleora Line Scan device...
100:11:25:05:424 : ERR: ERROR: PleoraLineScan::Connect Failed. MAC address indicates a non-Pleora device:
00:00:00:00:00:00
100:11:25:05:424 : ERR: Connect Device Failed: System has NO Imaging Device: 00:00:00:00:00:00
100:11:25:05:425 : ERR: The Connection to the Camera was dropped. Hardware is disconnected

```

● Disconnect / Try Connect

This toggle button is used to send a command to the node to tell it to either disconnect from or try to connect to its assigned scan head. This option is only available for nodes, it is not applicable to the system server.



Tips and Troubleshooting

F-1	Tips	F-2
F-1-1	I'm having trouble locating a synchronization region.	F-2
F-2	Troubleshooting	F-5
F-2-1	The V275 desktop icon isn't responding..	F-5
F-2-2	I entered the wrong password... ..	F-5
F-2-3	I'm getting an "ebnormal event" message. What does that mean?	F-6

F-1 Tips

F-1-1 I'm having trouble locating a synchronization region.

Training the synchronization requires the designer to select a region in the label image that contains content that does not change or is otherwise repeated for each item printed. For labels that contain multiple instances of repeated images, finding a good sync region can be challenging. The following approaches may help.

Create an intentional sync image in the label design.

If there is unused space in the label where an additional mark can be tolerated, print a unique image in this area and use it for synchronization. The label below consists of 12 repetitions of the same two barcode pattern. A black rectangle has been printed on the label to aid in finding a synchronization mark.

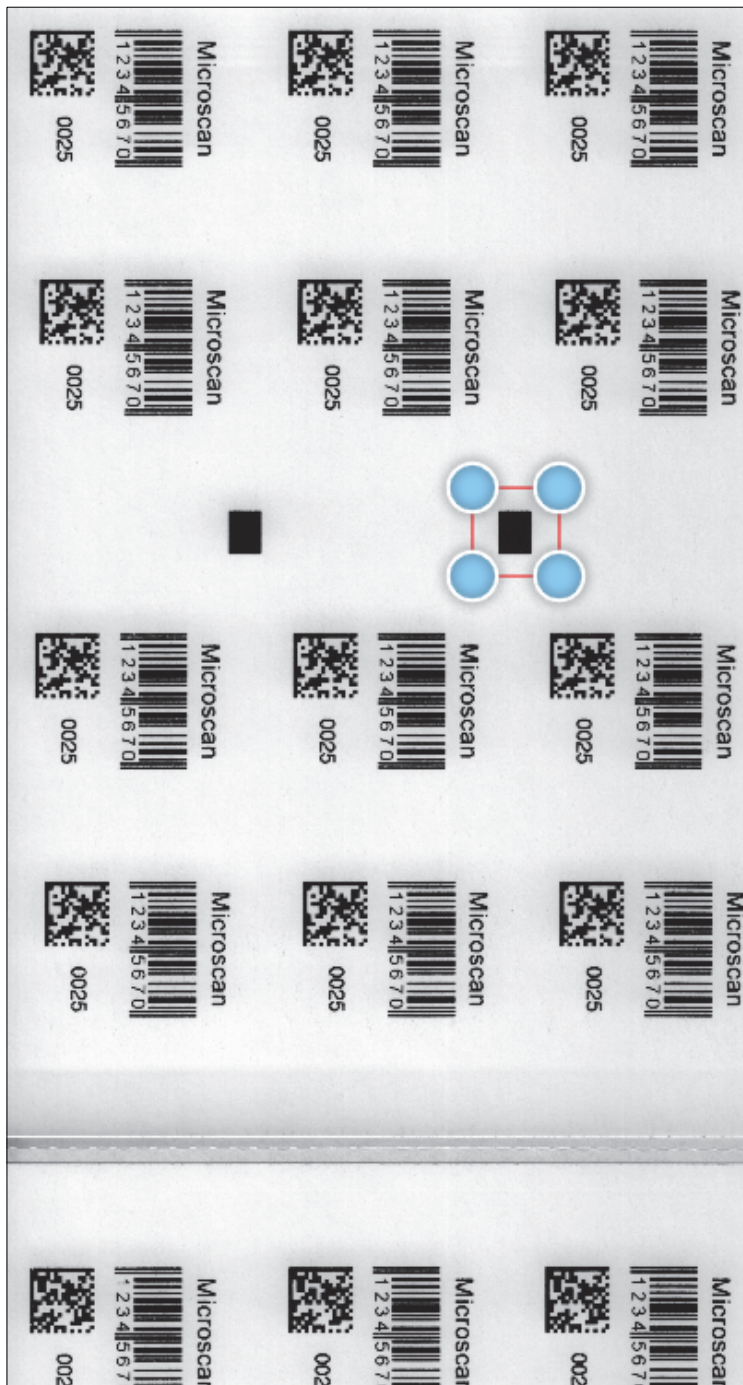

Vertically Repeated Inspections

There are some applications that implement redundant information vertically within the same label or item with no unique individual pattern per inspection and in which it is not practical or permitted to add a feature solely for inspection synchronization. To manage this type of case you can select a region that spans multiple vertical patterns to create a larger sync pattern that will sync on a per item frequency, reference the following example of four repeated sequenced on a single label.

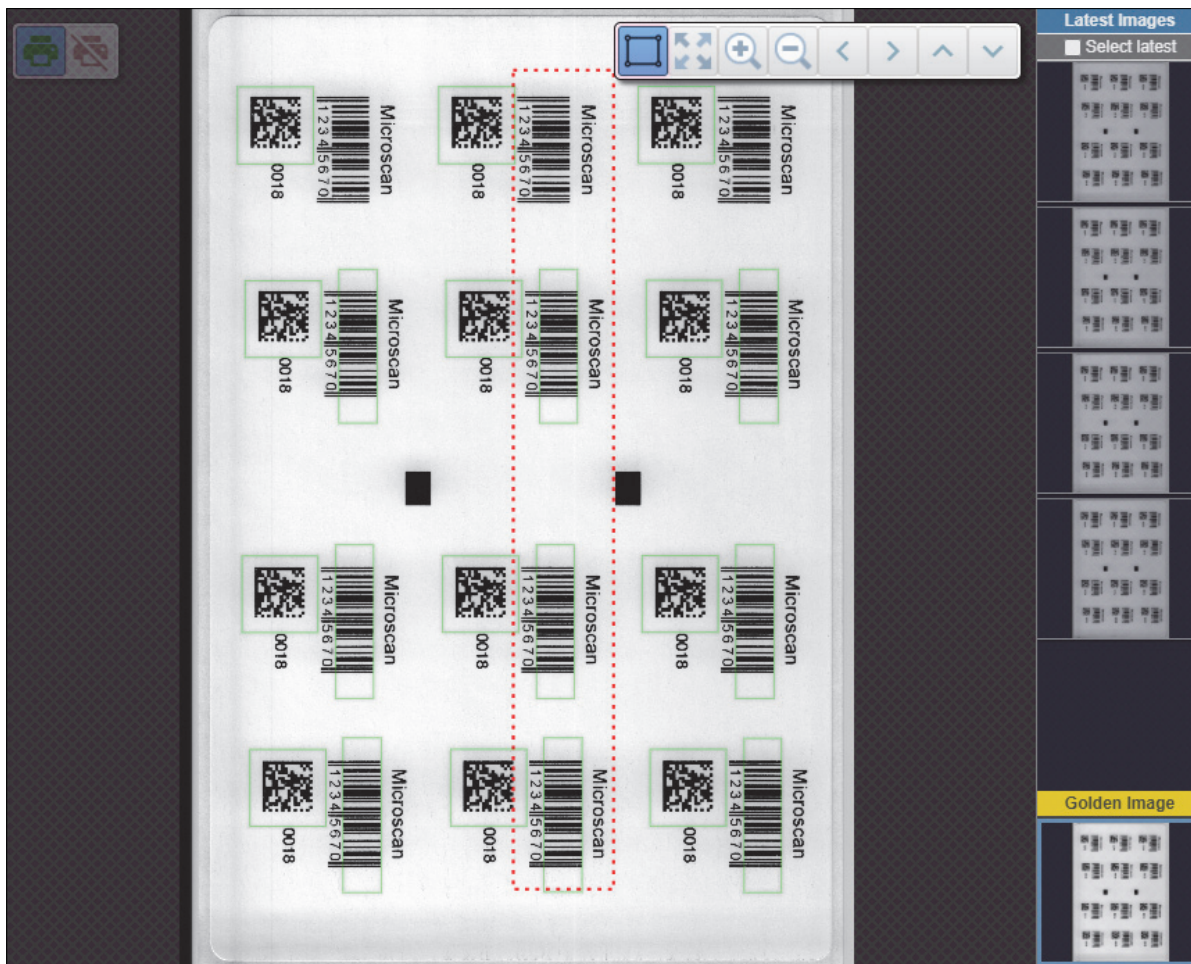

F

Additional Tips for Synchronization Training

Select a region that surrounds a feature or features that do not repeat vertically within that region area. The synchronization detection will search for a similar matching pattern within the vertical area defined by that region width reference the orange lines in the following figure. In this example there is no other print above or below the black rectangle. This will result in no chance of a false positive.

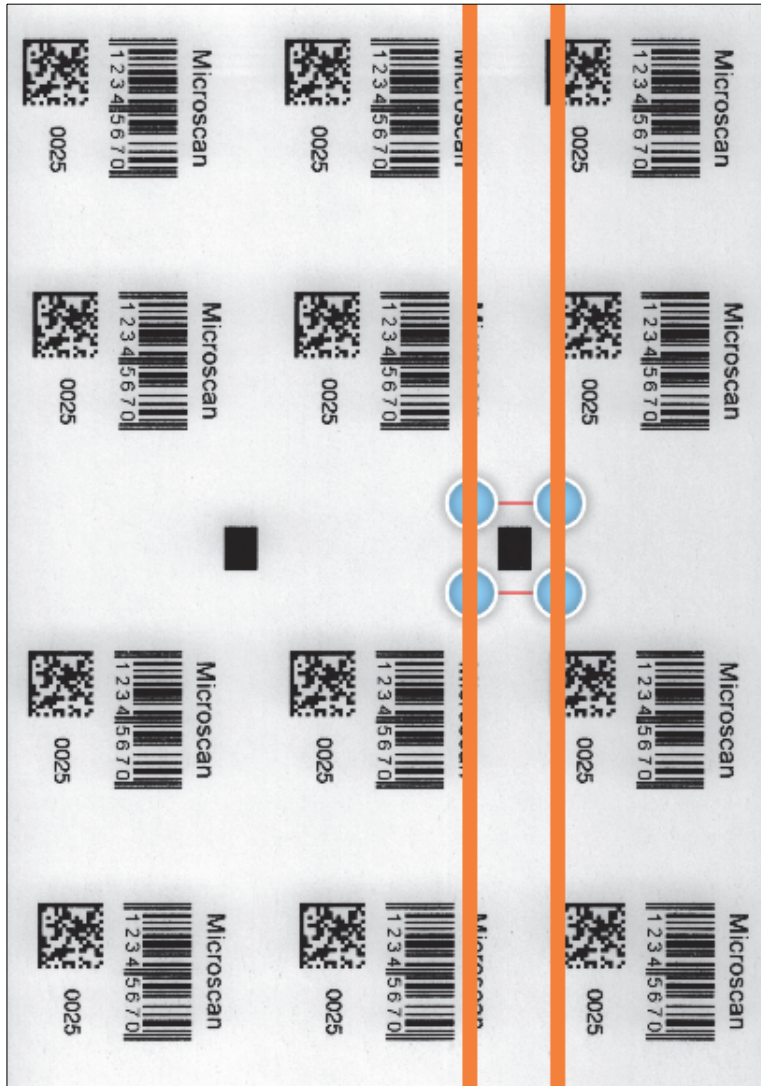

Having a distinct mark with no print above or below is ideal but not practical for many applications nor is it required to function. The pattern detection can discern accurately between various printed features. For a complex label with significant printed material, selection of a logo or a complete word should be adequate to train. Selecting a single letter or small feature in a complex changing label is not recommended. If there is concern or lack of confidence that the pattern won't be unique enough due to varying content to prevent potential false positives in future print jobs, then it is recommended to select a region containing patterns near the leading edge (first out of the printer) of the inspection area. This is due to this being first part of the item to be scanned and matched against. Once a match has been confirmed no other matching is allowed until the rest of the inspection area is scanned.

Synchronization Failures

The pattern matching can tolerate standard variance and some damage. In the case where the pattern is significantly damaged or missing then the V275 will trigger an inspection at the location expected based on the previous synchronization. The V275 will wait approximately 1/3 of a label before determining a miss has occurred and automatically trigger the inspection. In the case of a damaged mark this may still result in a valid inspection or may cause a failure and require user resolution.

F-2 Troubleshooting

F-2-1 The V275 desktop icon isn't responding.

The V275 Service has stopped.

If you can't access the V275 application by clicking on the desktop icon, the V275 Service may have stopped running. Restart the V275 Service using Component Services in Windows. Enter **component** into the search box in the Windows Taskbar. Launch Component Services.

- 1** Select **Services**;
- 2** Scroll down the list of services in the **Services (Local)** window and select **V275 Service**;
- 3** Select **Restart**.

F-2-2 I entered the wrong password.

If you attempt to login to an account, and you enter the wrong password 5 times, the account will be locked, and all subsequent attempts to login will be rejected. However, after 5 MINUTES, the account will automatically be unlocked. If a second attempt is made to log into to this same account, and the wrong password is entered 5 times again, then the account will be locked again, but the 5 minute auto-unlock feature will NOT be activated. An administrator will need to login and unlock the account in the Advanced admin settings page. Administrators are an exception to this rule, the admin account will never be permanently locked, it will always unlock itself after 5 minutes. Also, it should be noted that locked accounts are not persistent; they stay locked only as long as the service is running. Restarting the service will unlock all accounts.

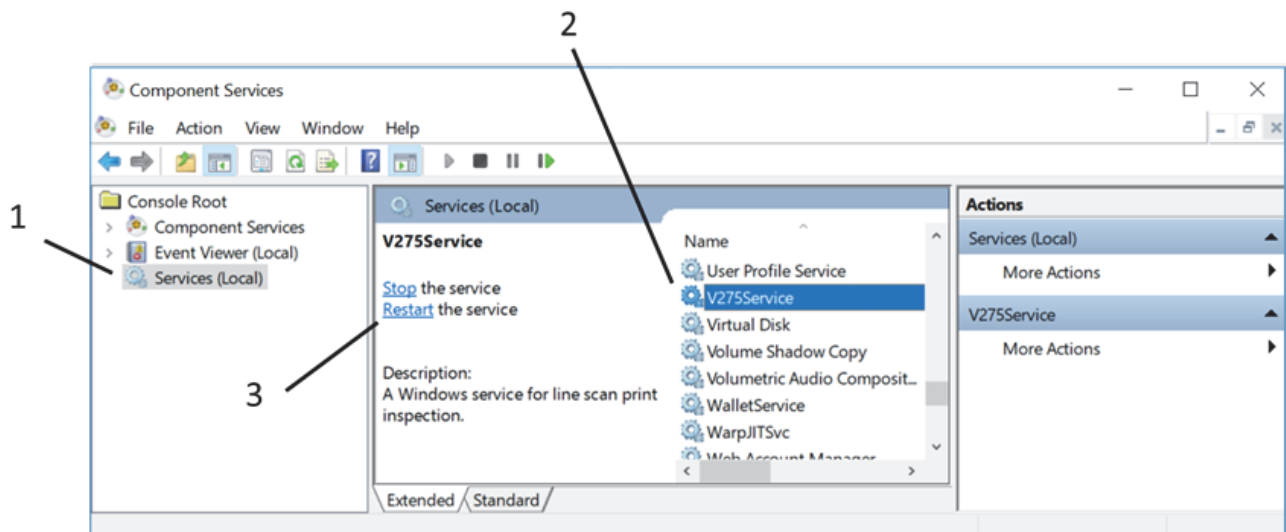

F-2-3 I'm getting an "abnormal event" message. What does that mean?

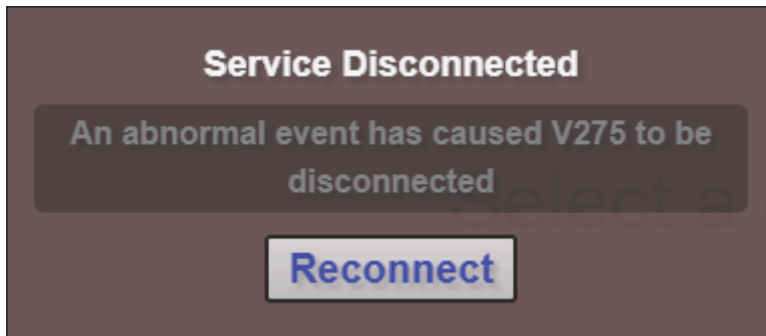

This message means the websocket connection to the V275 Service has been lost. Clicking **Reconnect** will typically reconnect to the server and restore the session.



Using Active Directory

G

G-1	Active Directory Setup	G-2
G-1-1	Overview	G-2

G-1 Active Directory Setup

This section describes how the V275 software should be configured to authenticate users via **Active Directory (AD)**.

G-1-1 Overview

The Omron V275 software requires users to login with a user name and password before they can access its features. By default, you setup user accounts that are stored locally on the V275 server PC. If you have many V275 systems however, it may be cumbersome to setup the same user accounts on every PC. If your V275 server PCs live on an Active Directory network, then you can setup your user accounts once on the Active Directory server, and then configure the V275 to connect to that server and let it handle user authentication services.

Enabling Active Directory Authentication Basics

- You must be a user with Administrator privileges to configure the Active Directory connection settings in the V275 software.
- Once logged in as an admin, you go to the **Advanced Admin Settings** page.

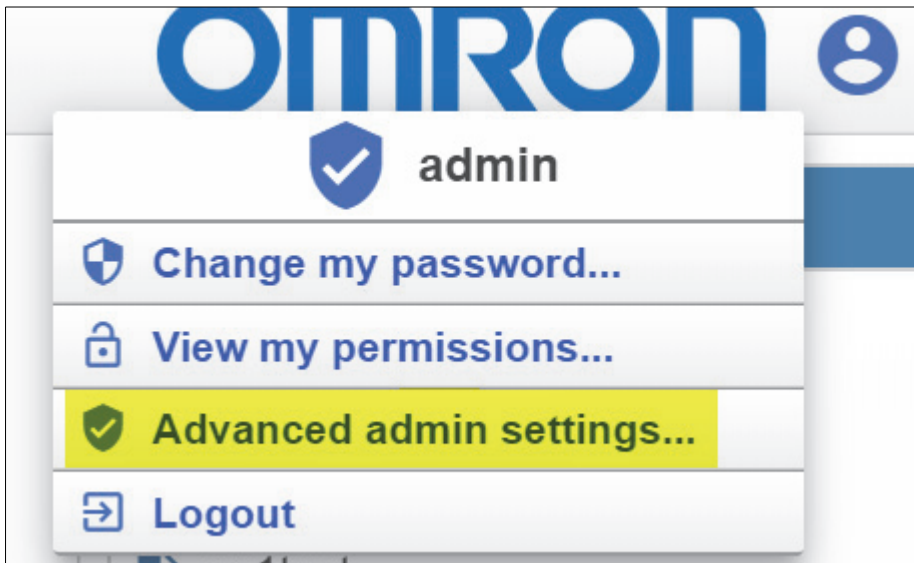

- In the right panel, you'll find the Active Directory Settings.

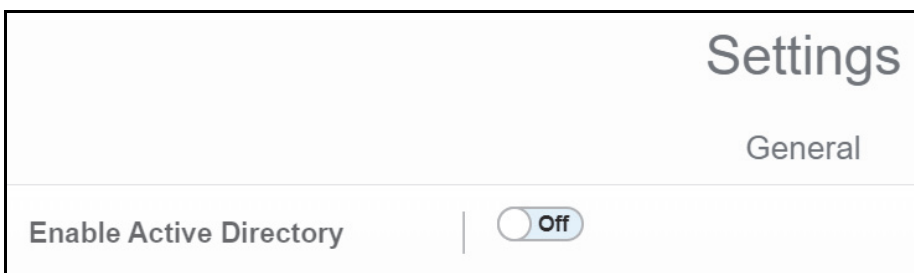

Active Directory is off by default. Turn it on to gain access to the various configuration settings.

Settings	
General	
Enable Active Directory	<input checked="" type="checkbox"/> On
AD Domain	
AD All Users	CN=V275Users,OU=Phase2,OU=AllUsers
AD Org Unit	V275Permissions
AD Enable Logging	<input type="checkbox"/> Off
Active Directory Group Names	
Allow Accept / Replace Errors	LVSAllowAcceptReplace
Administrator	LVSAllowAdministration
Allow Bypass / MakeReady	LVSAllowBypassMakeReady
Allow Calibration	LVSAllowCalibration
Allow Create NEW Template / Edit	LVSAllowCreateEdit
Allow Load EXISTING Template	LVSAllowLoadExisting
Allow Template Repository Changes	LVSAllowJobRepositoryChange

AD Domain: This should be set to the domain name of your Active Directory server.

AD All Users: This entry specifies the Active Directory group name that is used to identify the users that should have access to this machine. It should hold the full LDAP path to that user group. See the following Example section for more details.

Allow #####: Every field that starts with Allow represents a permission in the V275 software. Your IT administrator will need to create one group on your Active Directory Server for each V275 permission. You then grant permissions to your users by making them members of the groups that correspond to the permissions you wish to grant. In this section, you must enter the names of the groups that you created for each permission. Refer to the example section for more details.

AD Enable Logging: If you are having trouble getting Active Directory user authentication to work, you can turn on this option to get some diagnostic information. When turned on, this option will create a new log file in the **\Program Files\V275\data** folder, with the name **ActiveDirectory_<MAC Address>.log**.

Active Directory Server Configuration Requirements

Your Active Directory system administrator will need to make changes to the users and groups on the AD server in order to support Active Directory authentication in the V275. Briefly, they will need to do the following:

- Create a group to represent the users that should have access to the V275 system(s).
 - This group corresponds to the entry for **AD All Users** described in the previous section.
 - Each user account that should have access to the V275 system should be added to this group.
- Create one group for each of the permissions provided by the V275 software. The following permissions are provided:

Permission	Description
Administrator	User has full access to the software. No limits.
Allow Bypass / Make Ready	User can bypass failures when the system is in overstrike and repeat mode.
Allow to Create and Edit Jobs	User can create new jobs and edit existing jobs.
Allow Job Load	User can load different jobs.
Allow Calibration	User can calibrate the system.
Allow Accept / Replace	User can accept or replace errors during a label run.
Allow Template Repository Changes	User can bypass errors and enter the Make Ready screen.

- Go through each of the user accounts that should have access to the V275, and make each user a member of the groups that correspond to the permissions you wish to grant them.

● A More Detailed Example

Let's suppose that your V275 system must only be accessible by the users Bob, Mary, and Doug, and each should have the following permissions:

- **Bob:** Permission to Load Jobs and Accept / Replace errors.
- **Mary:** Administrative permissions, meaning she has full access to the system.
- **Doug:** All permissions except administrative.

Active Directory Server Configuration

- The AD admin would first create a user group that will be used to identify the group of users who should have access to this machine. Let's assume Bob, Mary, and Doug work in SectorG, so we will create a **SectorG** group. You could create an **Organizational Unit** (an OU folder) named **AdministeredGroups**, and inside of that you could create an OU named **OmronV275Groups**, and then create a group inside of that named **SectorG**. In the AD Administrative Center, that would look similar to this:

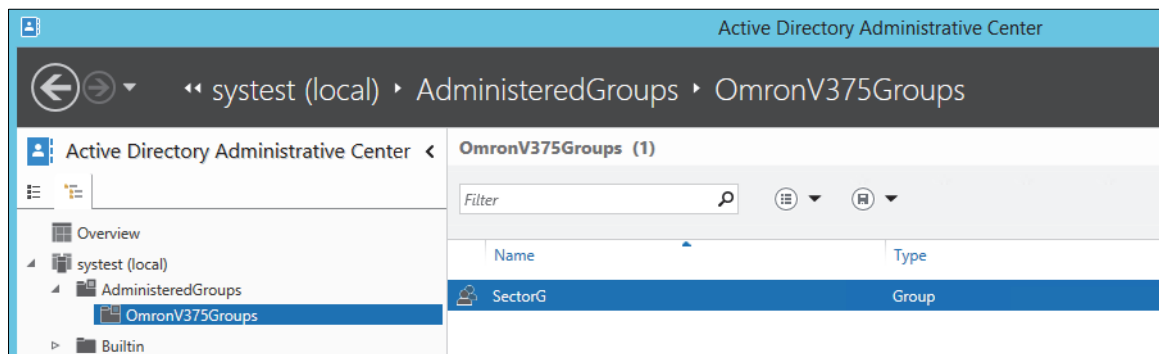

- Open the new **SectorG** group, go to the **Members** section, and make Bob, Mary, and Doug members of this group.

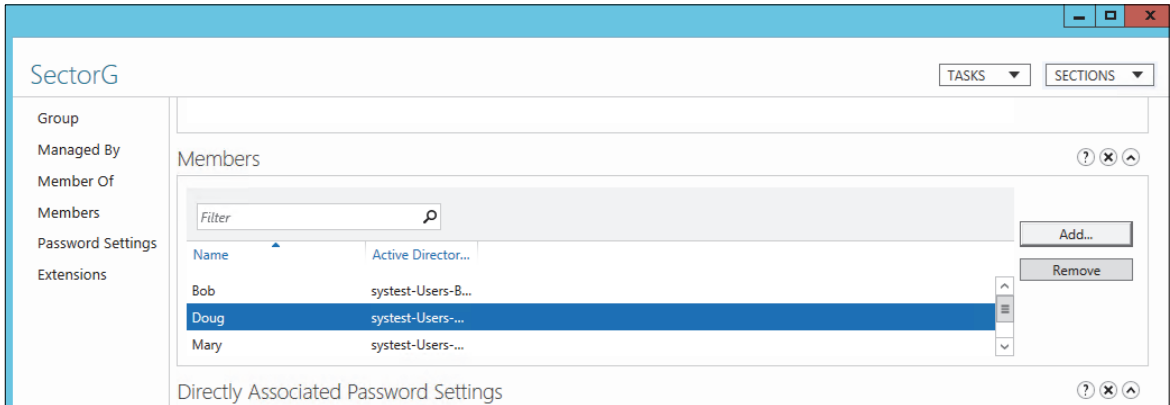

- Next, the AD admin must create one user group for each of the permissions provided by the Omron V275. The following table shows the list of possible permissions, and examples of what the permission groups might be named.

V275 Permission	Corresponding User Group in Active Directory
Administrator	LVSAllowAdministration
Allow to Create and Edit Jobs	LVSAllowCreateEdit
Allow to Load Existing Jobs	LVSAllowLoadExisting
Allow Calibration	LVSAllowCalibration
Allow Accept / Replace	LVSAllowAcceptReplace
Bypass / Make Ready	LVSAllowBypassMakeReady
Allow Template Repository Changes	LVSAllowJobRepositoryChange

Note: The group names shown here are only examples. You can name the groups whatever you want.
Important: You may choose to create a separate Permissions OU to hold all of the groups that will be associated with Omron V275 permissions.

- The AD admin would assign permissions to Bob, Mary, and Doug's accounts by making them members of the corresponding permission groups.
 - **Bob** should be allowed to load jobs and accept / replace errors, so he should be made a member of the groups **LVSAllowLoadExisting** and **LVSAllowAcceptReplace**.

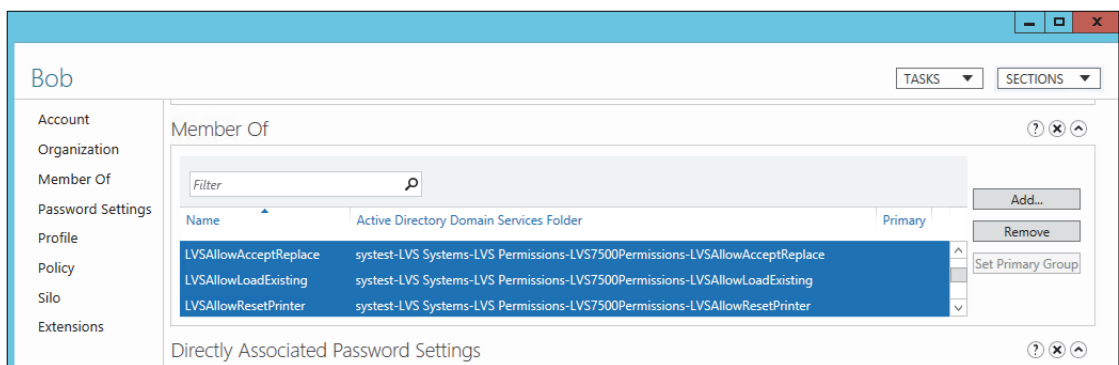

- **Mary** should be an administrator, so you only need to make her a member of the **LVSAllow Administration** group.

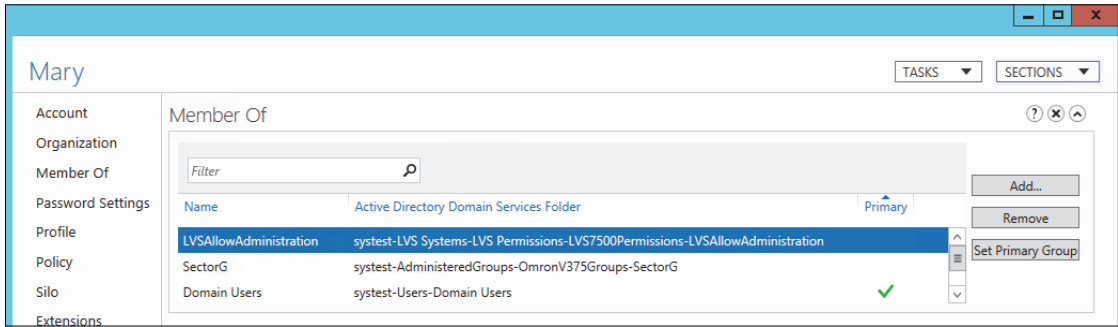

- **Doug** should have all permissions except administration, so he would be made a member of every group EXCEPT **LVSAllowAdministration**.

V275 Active Directory Configuration

Once everything is configured on the Active Directory server, you are ready to configure the V275.

- Log in to the V275 webpage as an admin. (Default username: **admin**. Default password: **admin**).
- Go to **Advanced Admin Settings**.

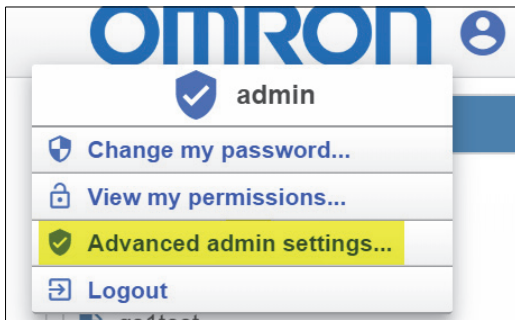

- In the **Settings** panel on the right of the page, go to **Enable Active Directory** and turn it on.



- **AD Domain:** Enter the domain name of your AD server. If you don't know the name, your AD administrator should be able to provide it to you. In our example, our AD server has a domain name of **systest.local**.



- **AD All Users:** In the previous section, we described how to setup the group "SectorG". This group defines all of the users that will be given access to this machine. You need to enter the LDAP path to this group (not including the domain). In this example, that would be:
CN=SectorG, OU=OmronV275Groups, OU=AdministeredGroups

Note: You can look up this LDAP path in the Active Directory Administrative Center by going to the group and opening up its property page. Scroll down to the “Extensions” section, and click on the tab for the **Attribute Editor**:

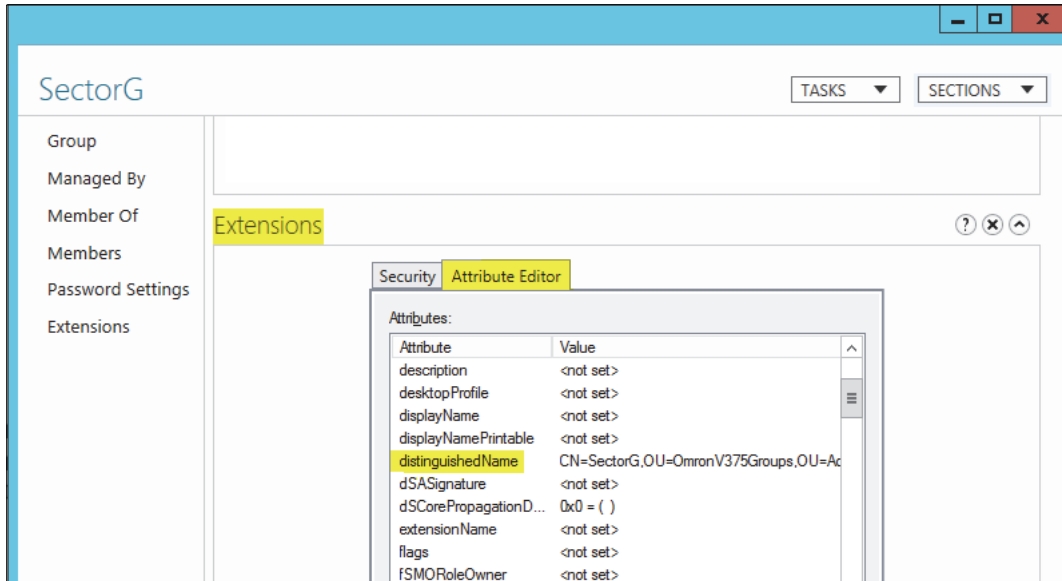

Find the value for “distinguishedName”, and double-click it. This will open the string attribute editor, and you can copy the string from here. BUT, be careful, because this path includes the domain at the end, and you don’t want to include that. So, in this example, the path looks like this:

CN=SectorG,OU=OmronV275Groups,OU=AdministeredGroups,DC=systest,DC=local

Just delete the “,DC=systest,DC=local” portion at the end, leaving you with:

CN=SectorG,OU=OmronV275Groups,OU=AdministeredGroups

Paste that string into the “AD All Users” setting.

- **Allw #####:** These fields need to be set to the group names you are using for the various permissions. So, based on the group names we’ve chosen for this example, the entries for each of these fields should look like this:

Allow Accept / Replace Errors	LVSAllowAcceptReplace
Administrator	LVSAllowAdministration
Allow Bypass / MakeReady	LVSAllowBypassMakeReady
Allow Calibration	LVSAllowCalibration
Allow Create NEW Template / Edit	LVSAllowCreateEdit
Allow Load EXISTING Template	LVSAllowLoadExisting
Allow Template Repository Changes	LVSAllowJobRepositoryChange

- Click the **Save** button at the bottom of the page to save all of your settings.

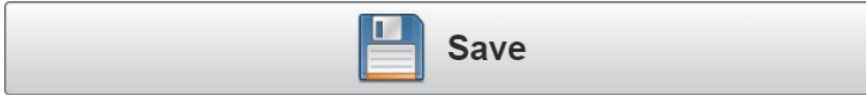

At this point, the V275 will attempt to connect to the specified **Active Directory Server** and load all of the user accounts. If we have configured everything correctly, we should see something like this:

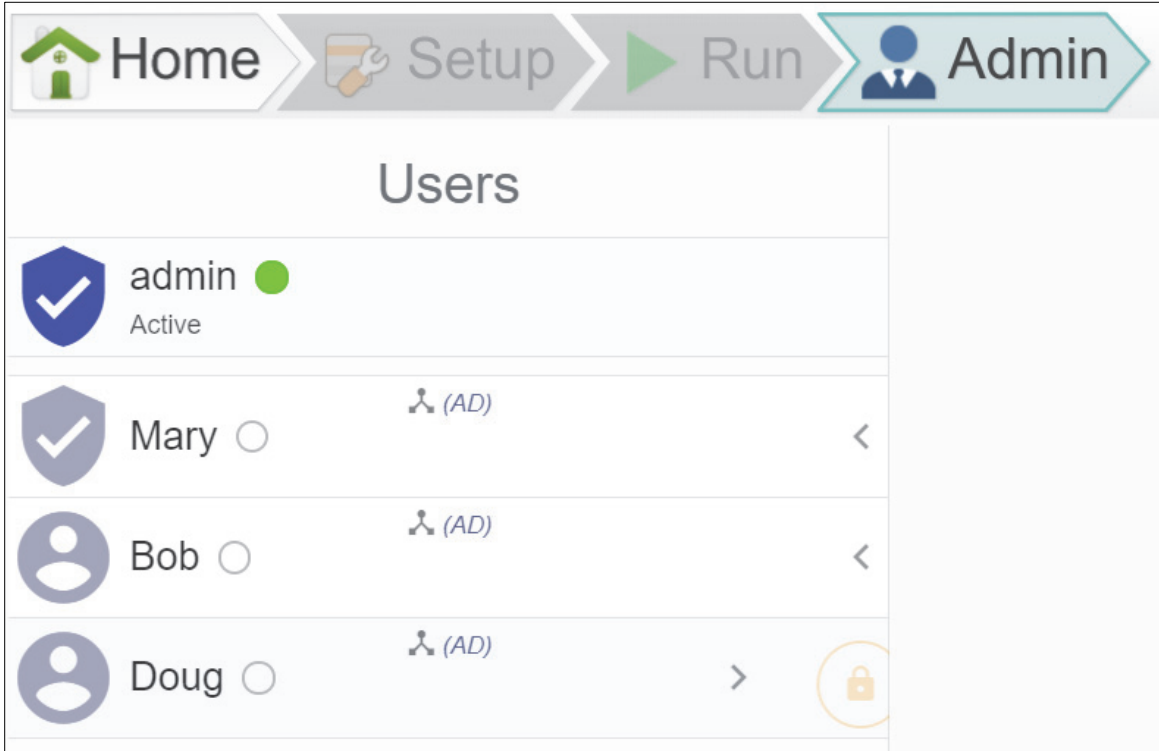

The default admin account is always present, but other than that, note that the only users listed are Mary, Bob and Doug. These are the only users who can login to this V275, because these are the only users we made members of the **SectorG** group, and the **AD All Users** setting was set to specify SectorG as the group that provides access to this system. There will most likely be many other users with credentials on this server, but they will not be able to log in to this system unless they are made members of the SectorG group.

Reloading User Accounts

Now that your V275 is fully configured for Active Directory use, you can force the software to reload the user accounts in one of two ways:

- 1** Restart the V275 Service, and the user accounts will be loaded during startup.
- 2** If you turn **Enable Active Directory** off from the **Settings** panel of the **Admin** page and then click **Save Changes** at the bottom, you will switch back to working with local user accounts. If you then turn **Enable Active Directory** back on and click **Save Changes** again, it will re-enable Active Directory functionality and reload the user accounts from the Active Directory Server using your settings.

OMRON Corporation Industrial Automation Company
Kyoto, JAPAN

Contact: www.ia.omron.com

Regional Headquarters

OMRON EUROPE B.V.

Wegalaan 67-69, 2132 JD Hoofddorp
The Netherlands
Tel: (31)2356-81-300/Fax: (31)2356-81-388

OMRON ELECTRONICS LLC

2895 Greenspoint Parkway, Suite 200
Hoffman Estates, IL 60169 U.S.A.
Tel: (1) 847-843-7900/Fax: (1) 847-843-7787

OMRON ASIA PACIFIC PTE. LTD.

No. 438A Alexandra Road # 05-05/08 (Lobby 2),
Alexandra Technopark,
Singapore 119967
Tel: (65) 6835-3011/Fax: (65) 6835-2711

OMRON (CHINA) CO., LTD.

Room 2211, Bank of China Tower,
200 Yin Cheng Zhong Road,
PuDong New Area, Shanghai, 200120, China
Tel: (86) 21-5037-2222/Fax: (86) 21-5037-2200

Authorized Distributor:

© OMRON Corporation 2020 All Rights Reserved.
In the interest of product improvement,
specifications are subject to change without notice.

Cat. No. 84-9310123-02-A

0820