



Warranty
2
YEAR

Compliant
IEC
62471

Compliant
CE
RoHS

Rated
IP
65

Connector
5 PIN
M12

PRODUCT HIGHLIGHTS

- ✓ 5-pin M12 quick connect
- ✓ Built-in driver, no external wiring to driver needed
- ✓ PNP and NPN strobe input
- ✓ 30 mm barrel style housing
- ✓ Standard optics provides tight focused light



PRODUCT DESCRIPTION

The SX30 Series of Prox Lights is enclosed in a 30mm Barrel Style Housing. The SX30 Series feature an NPN and PNP strobe signal with a 1–10VDC analog intensity control signal for added versatility. The SX30 Series has multiple mounting options allowing for ease of install and comes with two mounting nuts.



PRODUCT SPECIFICATIONS

Electrical Input	24VDC +/- 5%
Input Current	Max. 175 mA
Wattage	Max. 6 W
Strobe Input	PNP > +4VDC or greater to activate NPN > GND (<1VDC) to activate
PNP Line	4 mA @ 4VDC 10 mA @ 12VDC 20 mA @ 24VDC
NPN Line	15 mA @ Ground (0VDC)
Continuous Mode	NPN can be tied to ground OR PNP can be tied to 24VDC (not both)
Red Indicator LED	LED Strobe Indicator ON = Light Active
Green Indicator LED	ON = Power
Analog Intensity	The output is adjustable from 10%–100% of brightness by a 1–10VDC signal. (Jumpering pin 5 to pin 1 will provide maximum intensity)
Connection	5-pin M12 connector
Ambient Temperature	-18°–40° C (0°–104° F)
IP Rating	IP65
Weight	~320g
Compliances	CE, RoHS, IEC 62471
Warranty	2 years; see smartvisionlights.com/warranty for more information.



RESOURCE CORNER

Additional resources available on our website including CAD files, videos and application examples.

WIRING CONFIGURATION

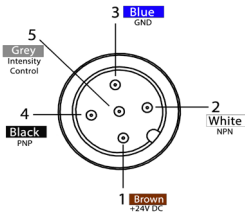

Pins	Function	Signal	Wire Color
1	Power In	+24VDC	BROWN
2	NPN	Sinking Signal	WHITE
3	GND	Ground	BLUE
4	PNP	Sourcing Signal	BLACK
5	Intensity Control	1-10VDC	GREY*

* Some cables use green/yellow for 1-10V adjustment

If Analog 1-10VDC is not used to control light intensity; +VDC (24VDC) must be connected to Analog Input - Jumper pin 5 to pin 1

Pin layout for light (Male Connector)

CONNECTING A 5-PIN M12 CABLE

WARNING:
When connecting a 5-pin M12 cable to the male connector on the SX30, **do not** twist the cable. Tighten the nut only. Twisting the cable may result in damage to the pins.

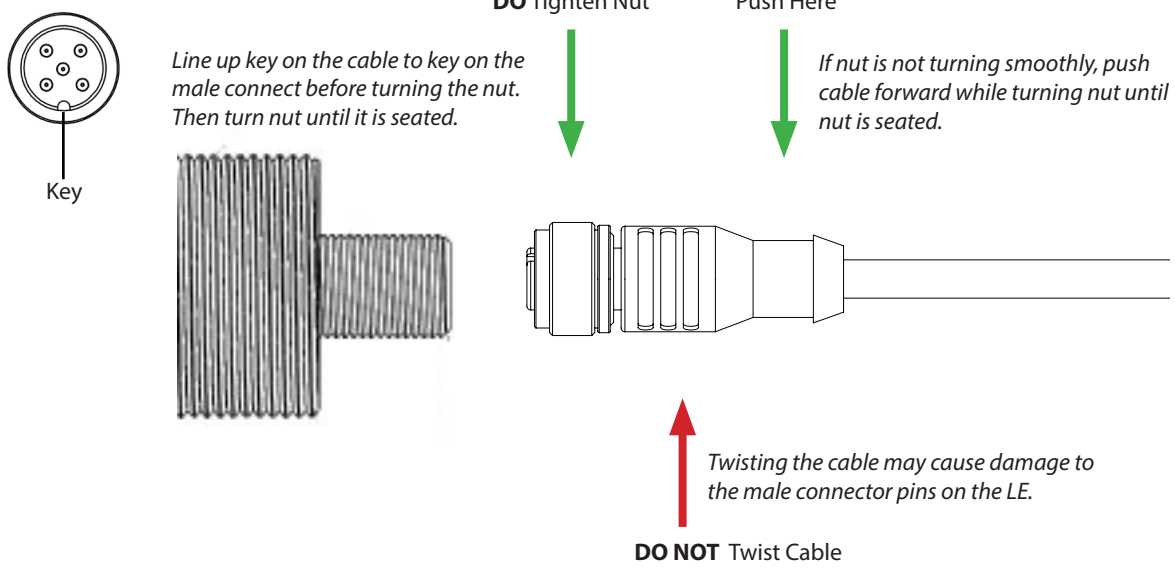



LIGHT PATTERNS

Smart Vision Lights recommends the SX30 be used at a working distance between 500 mm to 4000 mm.

Beam Diameter (White Light) – 6500 K

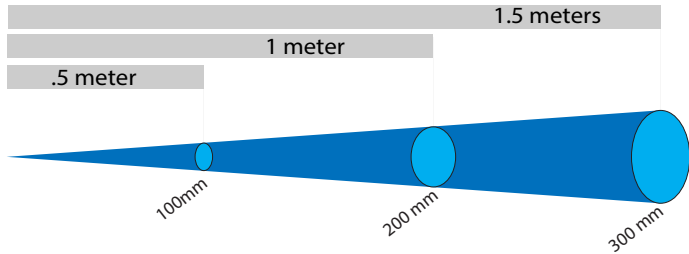

Beam Diameter (White Light) – 6500 K

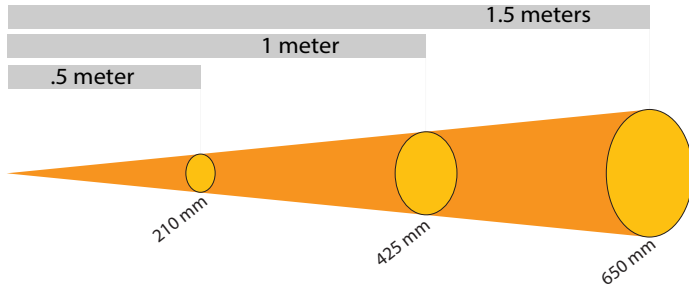

Beam Diameter (White Light) – 6500 K

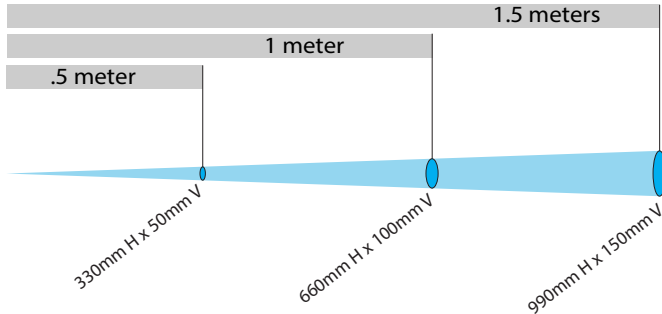

LIGHTING PATTERN FOR THE SX30 (NARROW)

Working Distance mm (inches)	Pattern (80% - 100% measured intensity) mm (inches)
.5m (19.7")	100mm (~4") D
1m (39.4")	200mm (~8") D
1.5m (59")	300mm (~12") D

Typical Output Performance	Illuminance (Lux)
Distance = .5 meter	9,600
<i>Illumination measurement taken on White Lights - 6500K</i>	

LIGHTING PATTERN FOR THE SX30 (WIDE)

Working Distance mm (inches)	Pattern (80% - 100% measured intensity) mm (inches)
.5m (19.7")	210mm (~6")
1m (39.4")	425mm (~17")
1.5m (59")	650mm (~22")

Typical Output Performance	Illuminance (Lux)
Distance = .5 meter	6,300
<i>Illumination measurement taken on White Lights - 6500K</i>	

LIGHTING PATTERN FOR THE SX30 (LINE)

Working Distance mm (inches)	Pattern (80% - 100% measured intensity) mm (inches)
.5m (19.7")	330mm (~13") H x 50mm (~2") V
1m (39.4")	660mm (~26") H x 100mm (~4") V
1.5m (59")	990mm (~39") H x 150mm (~6") V

Typical Output Performance	Illuminance (Lux)
Distance = .5 meter	10,000
<i>Illumination measurement taken on White Lights - 6500K</i>	

The SX30 Prox Light produces a uniform light pattern.

Working Distance = 500 mm Grid set to 25 mm x 25 mm

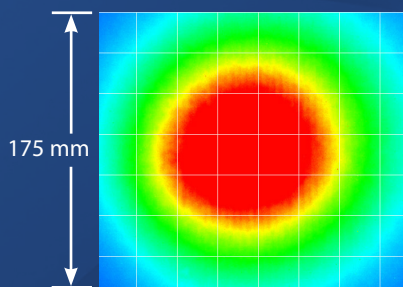

Narrow

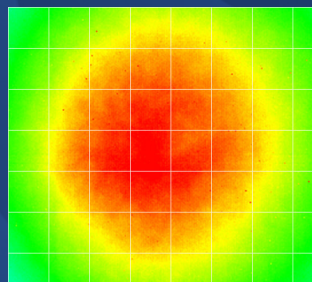

Wide

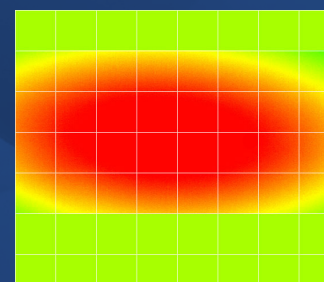

Line



PRODUCT DRAWING

CAD files available on our website.
Dimensions are in mm.

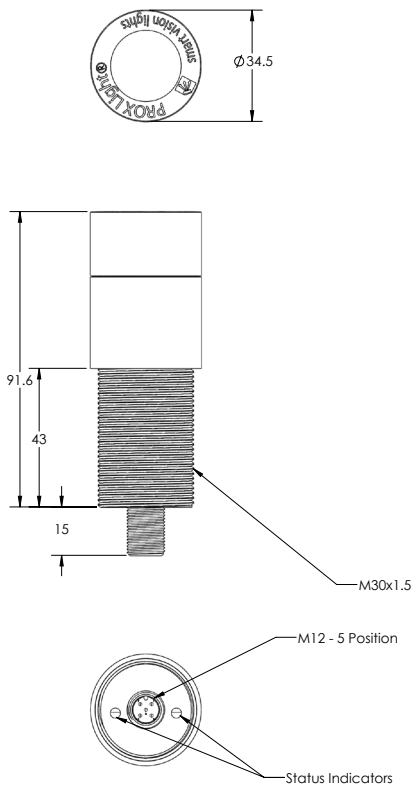

ILLUMINATION

SX30 series of Prox Spot Lights works best for:

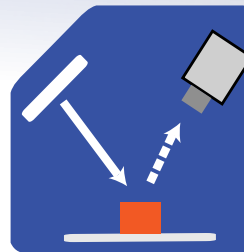

Bright Field

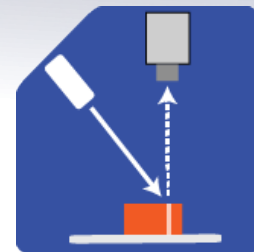

Projector



EYE SAFETY



According to IEC-62471:2006. Full documentation upon request

Notice

Exempt Group: No photobiological hazard to eyes or skin even for continuous, unrestricted use. Applicable for wavelengths: 625, 850, and 940.

Caution

Risk Group 1: Possibly hazardous optical radiation emitted from this product. Do not stare at operating lamp. May be harmful to eye. Safe for most applications except prolonged exposures. Applicable for wavelengths: 470, 505, 530, and WHI.

Notice

Risk Group 1: UV emitted from this product. Minimize exposure to eyes and skin. Use appropriate shielding. Safe for most applications except prolonged exposures. Applicable for wavelengths: 395

Caution

Risk Group 2: UV emitted from this product. Eye or skin irritation may result from exposure. Use appropriate shielding. Does not pose optical hazard if aversion responses limit exposure. Applicable for wavelengths: 365



PART NUMBER

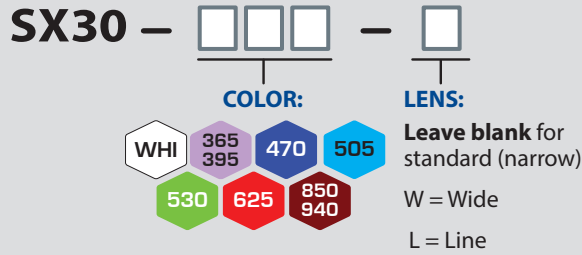

Part Number Examples:

- SX30-625** SX30, 625 nm Red Wavelength, Standard (Narrow) Lenses
- SX30-WHI-L** SX30, White, Line Lenses



This light is available in our SWIR LEDs (1050 nm, 1200 nm, 1300 nm, 1450 nm, 1550 nm)

Additional wavelengths options available upon request



STANDARD LENS OPTICS

NARROW

Narrow lens are standard.

Standard lenses create a narrow beam of illumination. They can be used when long working distances are needed. Narrow are 10° angle lenses.

WIDE

Wide lenses create a large area of illumination. Wide lenses can be used when short working distances are needed. Wide lenses create a flood light effect. Wide are 25° angle cone lenses.

LINE

Line lenses create a thin narrow beam of illumination. Line are 10° and 50° angle cone lenses.

* Additional lens options available upon request.

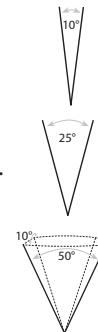

MOUNTING

Two M30 nuts for mounting are included with the light.

Example of the SX30 shown using the Slotted Right Angle mount (**Part Number: PB30-M3**).

See accessories for additional mounting options.

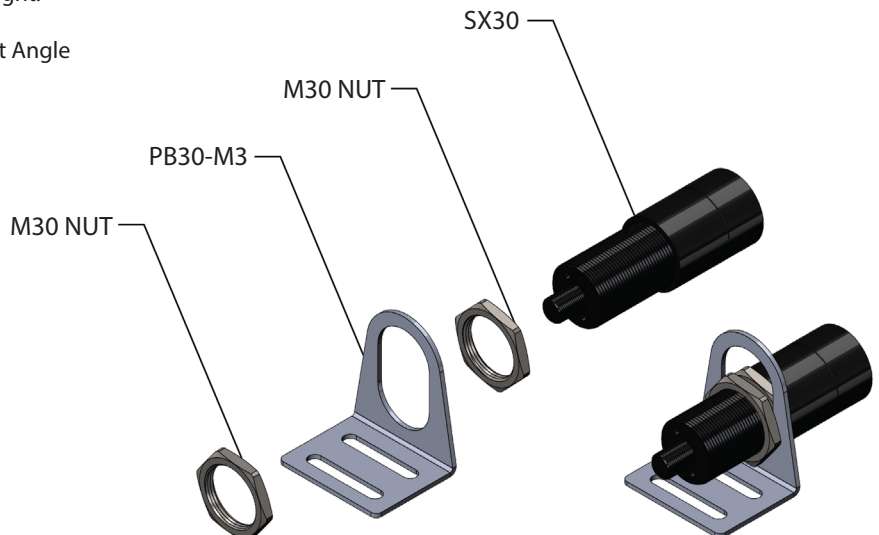





ACCESSORIES

Mount	
	
Description	Part Number
Swivel Mount	PB30-M1

Mount	
	
Description	Part Number
Slotted Block Mount	PB30-M2

Mount	
	
Description	Part Number
Slotted Right Angle	PB30-M3

Mount	
	
Description	Part Number
Blot-on Block Mount	PB30-M6

Power Cables	
	
Lengths	Part Number
5 m	5PM12-5
10 m	5PM12-10
15 m	5PM12-15



GLOSSARY

This glossary covers all Smart Vision Lights product families; some content in this section may not apply to this specific light.

TERMINOLOGY

OverDrive™ Lights include an integrated high-pulse driver for complete LED light control.

Continuous Operation Lights stay on continuously.

Multi-Drive™ Combines continuous operation and OverDrive™ strobe (high-pulse operation) mode into one easy-to-use light.

Built-in Driver The built-in driver allows full function without the need of an external controller.

Camera to Light Connecting the light directly to the camera, without the need for additional controllers or equipment.

Polarizers Filters that reduce reflections on specular surfaces.

Diffuser Used to widen the angle of light emission, reduce reflections, and increase uniformity.

TYPES OF ILLUMINATIONS

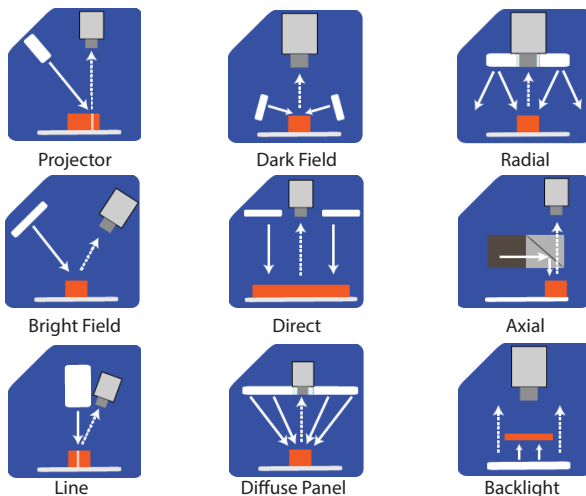

COLOR/WAVELENGTHS LEGEND

Wavelengths options range from 365 nm to 1550 nm. Additional wavelengths available for many light families.

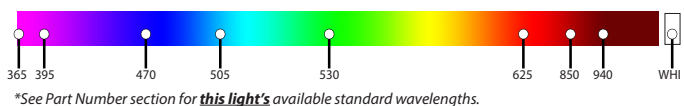

Shortwave infrared LEDs are available in 1050 nm, 1200 nm, 1300 nm, 1450 nm, and 1550 nm.*

*Check Part Number section to see if **this light** is available in SWIR wavelengths.